

CBRDFA4-100 4.0A, 1000V Bridge Rectifier in BR DFN-A package

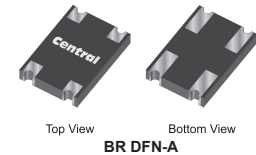
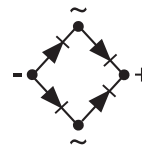

Central Semiconductor's **CBRDFA4-100** is a 4.0 amp full wave bridge rectifier mounted in a durable epoxy surface mount BR DFN-A case, utilizing glass passivated chips. Ideal for low profile power supplies and fast chargers in consumer, industrial, scientific, and medical applications.

Features

- High 4.0A current rating
- Low V_F Diodes (1.0V MAX @ $I_F=4.0A$)
- DFN style package

Applications

- Consumer & I/S/M built-in power supplies (low profile)
- Consumer & I/S/M fast chargers (low profile)

Benefits

- Energy efficiency
- Space-savings
- Exceptionally low profile package

Central Item No.	Maximum Ratings ($T_A=25^\circ C$)				Electrical Characteristics: ($T_A=25^\circ C$)					Case Type
	I_O (A) MAX	V_{RRM} (V) MAX	T_J, T_{stg} ($^\circ C$) MAX	I_{FSM} (A) MAX	V_F (V) TYP	V_F (V) MAX	@ I_F (A)	I_R (μA) MAX	@ V_R (V)	
CBRDFA4-100	4.0	1000	-55 to +175	150	0.95	1.0	4.0	5.0	1000	BR DFN-A

Ideal Applications:

AC/DC Linear Regulator: The CBRDFA4-100 can provide AC to DC voltage rectification for linear regulation in any high power adapter or supply. AC voltage is converted to DC voltage and processed by a smoothing capacitor, where it then powers a linear regulator, yielding a flat DC output.

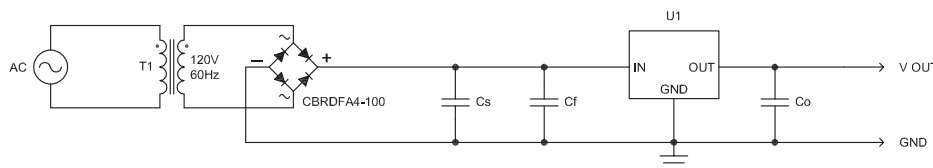

AC/DC Switched-Mode Power Supply: The CBRDFA4-100 provides a rectified DC signal to a PWM controlled MOSFET. The MOSFET acts as a switch, passing pulses of the signal through a transformer to a half-wave rectifier, which then converts the pulsed signal to DC. This DC signal is then used in a feedback loop with an optocoupler to power the PWM.

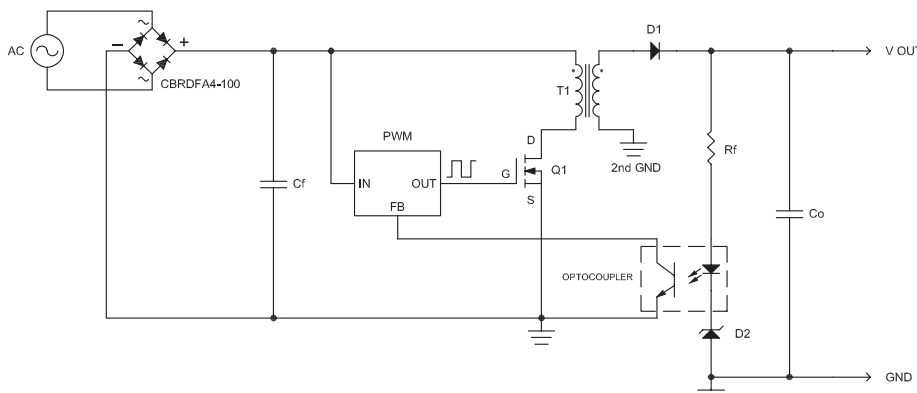

Typical Electrical Characteristics

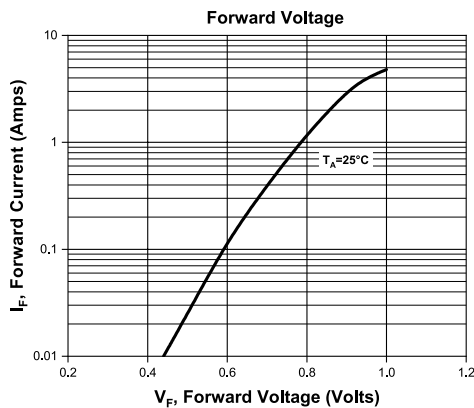
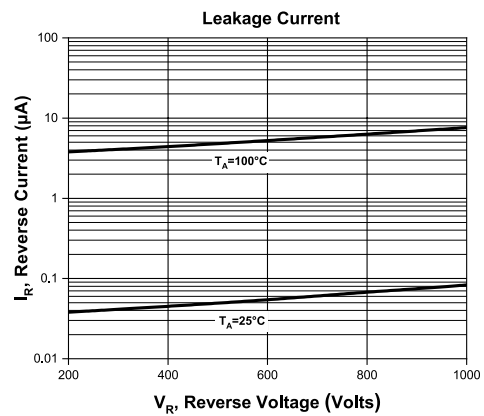
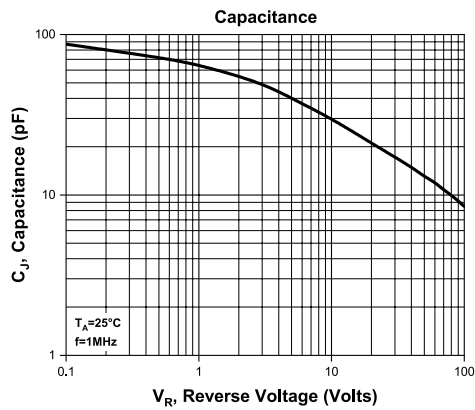
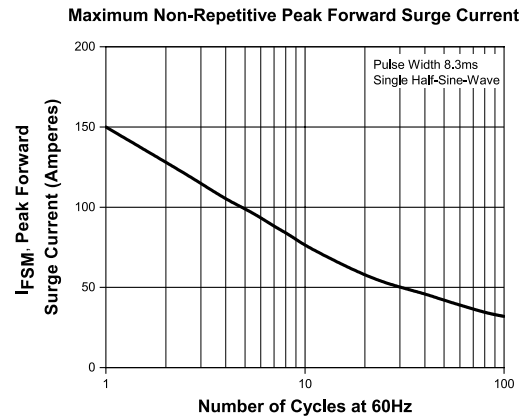
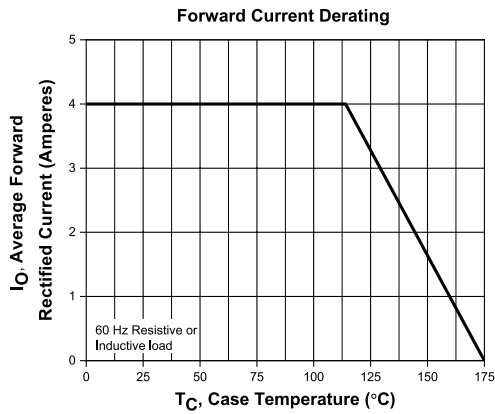

Custom solutions also available:

- custom device development
- special wafer diffusions
- custom interconnect options
- packaging options
- specialized parametric testing
- up-screening to MIL standard equivalents or to customer-specific criteria

SPICE Models and other technical resources:

Visit www.centalsemi.com to download SPICE models for these devices.

RoHS and REACH compliance declarations

Visit the Quality section of Central's website to access.

CBRDFA4-100

4.0A, 1000V Bridge Rectifier
in BR DFN-A package

Mechanical Drawing: BR DFN-A

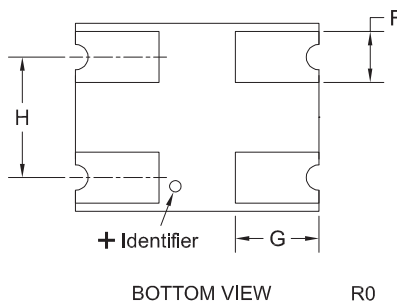
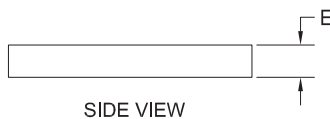
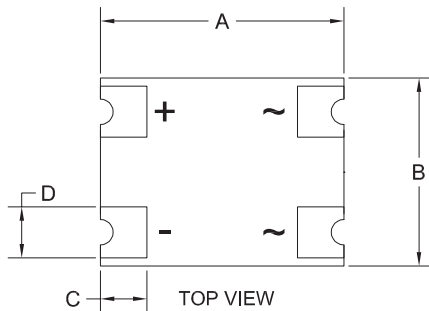

SYMBOL	DIMENSIONS			
	INCHES		MILLIMETERS	
	MIN	MAX	MIN	MAX
A	0.409	0.417	10.40	10.60
B	0.315	0.323	8.00	8.20
C	0.073	0.085	1.85	2.15
D	0.083	0.091	2.10	2.30
E	0.049	0.061	1.25	1.55
F	0.083	0.091	2.10	2.30
G	0.138	0.146	3.50	3.70
H	0.201	0.209	5.10	5.30

BR DFN-A (REV: R0)

MARKING CODE: BR4100

Tape Dimensions and Orientation (Dimensions in mm)

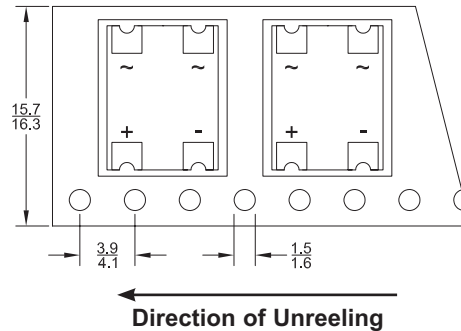

Tape Width: 16mm

Devices are taped in accordance with Electronic Industries Association Standard EIA-481-D

Mounting Pad Geometry (Dimensions in mm)

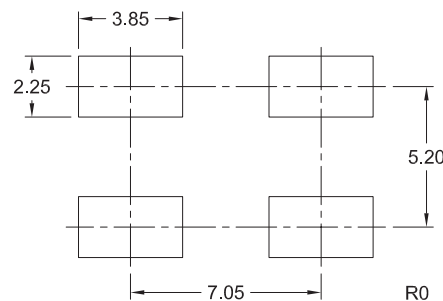

Packaging Base

Reel Size	Quantity
13"	3,000 pcs.

Reel Packing Information

Reel Size	Reels per Box (Maximum)	Parts per Box (Maximum)	Box Dimensions		Shipping Weight (Max.)	
			INCH	CM	LB	KG
13"	4	12,000	15x4x15	38x10x38	15	7
	11	33,000	15x15x9	38x38x23	41	19
	24	72,000	15x15x18	38x38x46	76	35

Ordering Information & Marking Code

Central Part No.	Marking Code	Orderable Part No.
CBRDFA4-100	BR4100	Add "TR13" as suffix to Central Part No. (ex: CBRDFA4-100 TR13)

For more information on Central's products and potential solutions:

Call us at: **1.631.435.1110**

Or view online: www.centrasemi.com/featured-products

