

# Test Report

No.: SHAEC23006090145

Date: May 24, 2023

Page 1 of 27

Client Name: Eterkon Semiconductor Materials Co., Ltd.

Client Address: 267 Qingyang Rd.(M),Kunshan, Jiangsu Province,P.R.China

Sample Name: EPOXY MOLDING COMPOUND  
 Model No.: EK-3600GT  
 Client Ref. Information: EK-3600GT, EK-3600GTM,  
 EK-3600GTL, EK-3600GTR,  
 EK-3600GTE,EK-3600GTF,  
 EK-3600GTRG,EK-3600GT-A  
 EK-3600GTRH,EK-3600GT-CRM  
 EK-3600GTHY  
 EK-3600GTGF  
 EK-3600GTV EK-3600GTY  
 Lot No.: 2023.04

The above sample(s) and information were provided by the client.

SGS Job No.: SHP23-002061  
 Sample Receiving Date: May 15, 2023  
 Testing Period: May 15, 2023 ~ May 24, 2023  
 Test Requested: Select test(s) as requested by the client.  
 Test Method(s): Please refer to next page(s).  
 Test Result(s): Please refer to next page(s).

Test Requirement	Conclusion
EU RoHS Directive (EU) 2015/863 amending Annex II to Directive 2011/65/EU- Lead, Mercury, Cadmium, Hexavalent chromium, Polybrominated biphenyls (PBBs), Polybrominated diphenyl ethers (PBDEs), Bis(2-ethylhexyl) phthalate (DEHP), Butyl benzyl phthalate (BBP), Dibutyl phthalate (DBP) and Diisobutyl phthalate (DIBP)	Pass
Alkanes C10-C13, chloro (short chain-chlorinated paraffins) (SCCPs)	See Results
Element(s)	See Results
Halogen	See Results

Signed for and on behalf of  
 SGS-CSTC Standards Technical Services (Shanghai) Co., Ltd.



Carol Luo  
 Approved Signatory

scan to see the report



03616102



Unless otherwise agreed in writing, this document is issued by the Company subject to its General Conditions of Service printed overleaf, available on request or accessible at <http://www.sgs.com/en/Terms-and-Conditions.aspx> and, for electronic format documents, subject to Terms and Conditions for Electronic Documents at <http://www.sgs.com/en/Terms-and-Conditions/Terms-e-Documents.aspx>. Attention is drawn to the limitation of liability, indemnification and jurisdiction issues defined therein. Any holder of this document is advised that information contained hereon reflects the Company's findings at the time of its intervention only and within the limits of Client's instructions, if any. The Company's sole responsibility is to its Client and this document does not exonerate parties to a transaction from exercising all their rights and obligations under the transaction documents. This document cannot be reproduced except in full, without prior written approval of the Company. Any unauthorized alteration, forgery or falsification of the content or appearance of this document is unlawful and offenders may be prosecuted to the fullest extent of the law. Unless otherwise stated the results shown in this test report refer only to the sample(s) tested.

Attention: To check the authenticity of testing /inspection report & certificate, please contact us at telephone: (86-755) 8307 1443, or email: CN.Doccheck@sgs.com

SGS-CSTC Standards Technical Services (Shanghai) Co., Ltd.  
 Testing Center-China

3<sup>rd</sup> Building, No.889 Yishan Road Xuhui District, Shanghai China 200233 t E&E (86-21) 61402553 f E&E (86-21)64953679 www.sgsgroup.com.cn  
 中国·上海·徐汇区宜山路889号3号楼 邮编: 200233 t HL (86-21) 61402594 f HL (86-21)61156899 e sgs.china@sgs.com

# Test Report

No.: SHAEC23006090145

Date: May 24, 2023

Page 2 of 27

Test Requirement	Conclusion
Hexabromocyclododecane (HBCDD)	See Results
Phthalates	See Results
Polychlorinated Biphenyls (PCBs)	See Results
Polychlorinated Naphthalenes (PCNs)	See Results
Polychlorinated Terphenyls (PCTs)	See Results
Polyvinyl chloride (PVC)	See Results
Red Phosphorus	See Results
TBBP-A	See Results
Organic-tin compounds	See Results
Perfluorooctane Sulfonates (PFOS) and its derivatives and Perfluorooctanoic Acid (PFOA) and its salts	See Results
Polycyclic Aromatic Hydrocarbons (PAHs)	See Results

## Test Result(s):

### Test Part Description:

SN ID	Sample No.	SGS Sample ID	Description
SN1	A3	SHA23-0060901-0001.C003	Grey solid

### Remarks:

- (1) 1 mg/kg = 1 ppm = 0.0001%
- (2) MDL = Method Detection Limit
- (3) ND = Not Detected (< MDL)
- (4) "-" = Not Regulated

**EU RoHS Directive (EU) 2015/863 amending Annex II to Directive 2011/65/EU- Lead, Mercury, Cadmium, Hexavalent chromium, Polybrominated biphenyls (PBBs), Polybrominated diphenyl ethers (PBDEs), Bis(2-ethylhexyl) phthalate (DEHP), Butyl benzyl phthalate (BBP), Dibutyl phthalate (DBP) and Diisobutyl phthalate (DIBP)**

Test Method: With reference to IEC 62321-4:2013+AMD1:2017, IEC 62321-5:2013, IEC 62321-7-2:2017, IEC 62321-6:2015 and IEC 62321-8:2017, analysis was performed by ICP-OES, UV-Vis and GC-MS.

Test Item(s)	Limit	Unit(s)	MDL	A3
Cadmium (Cd)	100	mg/kg	2	ND
Lead (Pb)	1000	mg/kg	2	ND
Mercury (Hg)	1000	mg/kg	2	ND
Hexavalent Chromium (Cr(VI))	1000	mg/kg	8	ND
Polybromobiphenyl (PBBs)	1000	mg/kg	-	ND
Monobromobiphenyl (MonoBB)	-	mg/kg	5	ND



Unless otherwise agreed in writing, this document is issued by the Company subject to its General Conditions of Service printed overleaf, available on request or accessible at <http://www.sgs.com/en/Terms-and-Conditions.aspx> and, for electronic format documents, subject to Terms and Conditions for Electronic Documents at <http://www.sgs.com/en/Terms-and-Conditions/Terms-e-Documents.aspx>. Attention is drawn to the limitation of liability, indemnification and jurisdiction issues defined therein. Any holder of this document is advised that information contained hereon reflects the Company's findings at the time of its intervention only and within the limits of Client's instructions, if any. The Company's sole responsibility is to its Client and this document does not exonerate parties to a transaction from exercising all their rights and obligations under the transaction documents. This document cannot be reproduced except in full, without prior written approval of the Company. Any unauthorized alteration, forgery or falsification of the content or appearance of this document is unlawful and offenders may be prosecuted to the fullest extent of the law. Unless otherwise stated the results shown in this test report refer only to the sample(s) tested.

Attention: To check the authenticity of testing /inspection report & certificate, please contact us at telephone: (86-755) 8307 1443, or email: [CN.Doccheck@sgs.com](mailto:CN.Doccheck@sgs.com)

SGS-CSTC (Shanghai) Technical Services (Shanghai) Co., Ltd.  
Testing Center-Chemical Laboratory

3<sup>rd</sup> Building, No. 889 Yishan Road Xuhui District, Shanghai China 200233  
中国·上海·徐汇区宜山路889号3号楼 邮编: 200233

t E&E (86-21) 61402553 f E&E (86-21) 64953679 www.sgsgroup.com.cn  
t HL (86-21) 61402594 f HL (86-21) 61156899 e sgs.china@sgs.com

# Test Report

No.: SHAEC23006090145

Date: May 24, 2023

Page 3 of 27

Test Item(s)	Limit	Unit(s)	MDL	A3
Dibromobiphenyl (DiBB)	-	mg/kg	5	ND
Tribromobiphenyl (TriBB)	-	mg/kg	5	ND
Tetrabromobiphenyl (TetraBB)	-	mg/kg	5	ND
Pentabromobiphenyl (PentaBB)	-	mg/kg	5	ND
Hexabromobiphenyl (HexaBB)	-	mg/kg	5	ND
Heptabromobiphenyl (HeptaBB)	-	mg/kg	5	ND
Octabromobiphenyl (OctaBB)	-	mg/kg	5	ND
Nonabromobiphenyl (NonaBB)	-	mg/kg	5	ND
Decabromobiphenyl (DecaBB)	-	mg/kg	5	ND
Polybromodiphenyl ether(PBDEs)	1000	mg/kg	-	ND
Monobromodiphenylether (MonoBDE)	-	mg/kg	5	ND
Dibromodiphenylether (DiBDE)	-	mg/kg	5	ND
Tribromodiphenylether (TriBDE)	-	mg/kg	5	ND
Tetrabromodiphenylether (TetraBDE)	-	mg/kg	5	ND
Pentabromodiphenylether (PentaBDE)	-	mg/kg	5	ND
Hexabromodiphenylether (HexaBDE)	-	mg/kg	5	ND
Heptabromodiphenylether (HeptaBDE)	-	mg/kg	5	ND
Octabromodiphenylether (OctaBDE)	-	mg/kg	5	ND
Nonabromodiphenylether (NonaBDE)	-	mg/kg	5	ND
Decabromodiphenylether (DecaBDE)	-	mg/kg	5	ND
Dibutyl Phthalate(DBP)	1000	mg/kg	50	ND
Benzyl Butyl Phthalate(BBP)	1000	mg/kg	50	ND
Bis-(2-ethylhexyl) Phthalate(DEHP)	1000	mg/kg	50	ND
Diisobutyl Phthalate(DIBP)	1000	mg/kg	50	ND

**Notes:**

- (1) The maximum permissible limit is quoted from RoHS Directive (EU) 2015/863.
- (2) IEC 62321 series is equivalent to EN 62321 series.
- (3) The restriction of DEHP, BBP, DBP and DIBP shall apply to medical devices, including in vitro medical devices, and monitoring and control instruments, including industrial monitoring and control instruments, from 22 July 2021.

**Alkanes C10-C13, chloro (short chain-chlorinated paraffins) (SCCPs)**

Test Method: With reference to ISO 18219-1:2021, analysis was performed by GC-NCI-MS.

Test Item(s)	CAS No.	Unit(s)	MDL	A3
Short Chain Chlorinated Paraffin(C10-C13)(SCCP)	85535-84-8	mg/kg	50	ND

**Element(s)**

Test Method: With reference to US EPA 3052:1996, analysis was performed by ICP-OES.

Test Item(s)	Unit(s)	MDL	A3
Arsenic(As)	mg/kg	10	ND
Beryllium(Be)	mg/kg	5	ND
Phosphorus(P)	mg/kg	20	1275
Antimony(Sb)	mg/kg	10	ND



Unless otherwise agreed in writing, this document is issued by the Company subject to its General Conditions of Service printed overleaf, available on request or accessible at <http://www.sgs.com/en/Terms-and-Conditions.aspx> and, for electronic format documents, subject to Terms and Conditions for Electronic Documents at <http://www.sgs.com/en/Terms-and-Conditions/Terms-e-Documents.aspx>. Attention is drawn to the limitation of liability, indemnification and jurisdiction issues defined therein. Any holder of this document is advised that information contained hereon reflects the Company's findings at the time of its intervention only and within the limits of Client's instructions, if any. The Company's sole responsibility is to its Client and this document does not exonerate parties to a transaction from exercising all their rights and obligations under the transaction documents. This document cannot be reproduced except in full, without prior written approval of the Company. Any unauthorized alteration, forgery or falsification of the content or appearance of this document is unlawful and offenders may be prosecuted to the fullest extent of the law. Unless otherwise stated the results shown in this test report refer only to the sample(s) tested.

Attention: To check the authenticity of testing /inspection report & certificate, please contact us at telephone: (86-755) 8307 1443, or email: [CN.Doccheck@sgs.com](mailto:CN.Doccheck@sgs.com)

3<sup>rd</sup> Building, No.889 Yishan Road Xuhui District, Shanghai China 200233 t E&E (86-21) 61402553 f E&E (86-21) 64953679 www.sgsgroup.com.cn  
 中国·上海·徐汇区宜山路889号3号楼 邮编: 200233 t HL (86-21) 61402594 f HL (86-21) 61156899 e [sgs.china@sgs.com](mailto:sgs.china@sgs.com)

# Test Report

No.: SHAEC23006090145

Date: May 24, 2023

Page 4 of 27

## Halogen

Test Method: With reference to EN 14582:2016, analysis was performed by IC.

Test Item(s)	Unit(s)	MDL	A3
Fluorine(F)	mg/kg	20	ND
Chlorine(Cl)	mg/kg	50	79
Bromine(Br)	mg/kg	50	ND
Iodine(I)	mg/kg	50	ND

## Hexabromocyclododecane (HBCDD)

Test Method: With reference to IEC 62321-9:2021, analysis was performed by GC-MS.

Test Item(s)	CAS No.	Unit(s)	MDL	A3
Hexabromocyclododecane (HBCDD)	134237-50-6 /134237-51-7 /134237-52-8 /25637-99-4 /3194-55-6	mg/kg	20	ND

## Phthalates

Test Method: With reference to IEC 62321-8:2017, analysis was performed by GC-MS.

Test Item(s)	CAS No.	Unit(s)	MDL	A3
Diisononyl Phthalate (DINP)	28553-12-0 /68515-48-0	mg/kg	50	ND
Di-n-Octyl Phthalate(DNOP)	117-84-0	mg/kg	50	ND
Diisodecyl Phthalate (DIDP)	26761-40-0 /68515-49-1	mg/kg	50	ND
Bis(2-methoxyethyl)phthalate(DMEP)	117-82-8	mg/kg	50	ND
Di-n-Hexyl Phthalate(DnHP)	84-75-3	mg/kg	50	ND
Dipentyl Phthalate	131-18-0	mg/kg	50	ND
Diphenyl Phthalate(DPhP)	84-62-8	mg/kg	50	ND
Dimethyl Phthalate(DMP)	131-11-3	mg/kg	50	ND
Diethyl Phthalate(DEP)	84-66-2	mg/kg	50	ND
Dipropyl Phthalate(DPrP)	131-16-8	mg/kg	50	ND
Dicyclohexyl Phthalate(DCHP)	84-61-7	mg/kg	50	ND
Dibenzyl Phthalate(DBzP)	523-31-9	mg/kg	50	ND
Dinonyl Phthalate(DNP)	84-76-4	mg/kg	50	ND
Diisooctyl Phthalate(DIOP)	27554-26-3	mg/kg	50	ND
Diisopentyl Phthalate(DIPP)	605-50-5	mg/kg	50	ND
1,2-Benzenedicarboxylic Acid, di-C6-8-branched alkyl esters, C7-rich(DIHP)	71888-89-6	mg/kg	50	ND
1,2-Benzenedicarboxylic Acid, Di-C7-11-Branched and Linear Alkyl Esters(DHNP)	68515-42-4	mg/kg	50	ND



Unless otherwise agreed in writing, this document is issued by the Company subject to its General Conditions of Service printed overleaf, available on request or accessible at <http://www.sgs.com/en/Terms-and-Conditions.aspx> and, for electronic format documents, subject to Terms and Conditions for Electronic Documents at <http://www.sgs.com/en/Terms-and-Conditions/Terms-e-Documents.aspx>. Attention is drawn to the limitation of liability, indemnification and jurisdiction issues defined therein. Any holder of this document is advised that information contained hereon reflects the Company's findings at the time of its intervention only and within the limits of Client's instructions, if any. The Company's sole responsibility is to its Client and this document does not exonerate parties to a transaction from exercising all their rights and obligations under the transaction documents. This document cannot be reproduced except in full, without prior written approval of the Company. Any unauthorized alteration, forgery or falsification of the content or appearance of this document is unlawful and offenders may be prosecuted to the fullest extent of the law. Unless otherwise stated the results shown in this test report refer only to the sample(s) tested.

Attention: To check the authenticity of testing /inspection report & certificate, please contact us at telephone: (86-755) 8307 1443, or email: [CN.Doccheck@sgs.com](mailto:CN.Doccheck@sgs.com)

SGS-CTC (Shanghai) Technical Services Co., Ltd.  
Testing Center-Chemical Laboratory

3<sup>rd</sup> Building, No.889 Yishan Road Xuhui District, Shanghai China 200233  
中国·上海·徐汇区宜山路889号3号楼 邮编: 200233

t E&E (86-21) 61402553 f E&E (86-21) 64953679 www.sgsgroup.com.cn  
t HL (86-21) 61402594 f HL (86-21) 61156899 e sgs.china@sgs.com

# Test Report

No.: SHAEC23006090145

Date: May 24, 2023

Page 5 of 27

Test Item(s)	CAS No.	Unit(s)	MDL	A3
1,2-Benzenedicarboxylic Acid, di-C6-10-Alkyl Esters, 1,2-Benzenedicarboxylic Acid, Mixed Decyl and Hexyl and Octyl Diesters with ≥ 0.3% of Dihexyl Phthalate	68515-51-5 / 68648-93-1	mg/kg	100	ND

## Polychlorinated Biphenyls (PCBs)

Test Method: With reference to US EPA 8082A:2007, analysis was performed by GC-MS.

Test Item(s)	CAS No.	Unit(s)	MDL	A3
2,4,4'-Trichlorobiphenyl (PCB28)	7012-37-5	mg/kg	0.5	ND
2,2',5,5'-Tetrachlorobiphenyl (PCB52)	35693-99-3	mg/kg	0.5	ND
2,2',4,5,5'-Pentachlorobiphenyl (PCB101)	37680-73-2	mg/kg	0.5	ND
2,3',4,4',5-Pentachlorobiphenyl (PCB118)	31508-00-6	mg/kg	0.5	ND
2,2',3,4,4',5'-Hexachlorobiphenyl (PCB138)	35065-28-2	mg/kg	0.5	ND
2,2',4,4',5,5'-Hexachlorobiphenyl (PCB153)	35065-27-1	mg/kg	0.5	ND
2,2',3,4,4',5,5'-Heptachlorobiphenyl (PCB180)	35065-29-3	mg/kg	0.5	ND
Sum of PCBs	-	mg/kg	-	ND

## Polychlorinated Naphthalenes (PCNs)

Test Method: With reference to US EPA 8081B:2007, analysis was performed by GC-MS.

Test Item(s)	CAS No.	Unit(s)	MDL	A3
1-Chlorinated Naphthalene	90-13-1	mg/kg	5	ND
2-Chlorinated Naphthalene	91-58-7	mg/kg	5	ND
1,4-Dichlorinated Naphthalene	1825-31-6	mg/kg	5	ND
1,5-Dichlorinated Naphthalene	1825-30-5	mg/kg	5	ND
1,2-Dichlorinated Naphthalene	2050-69-3	mg/kg	5	ND
1,8-Dichlorinated Naphthalene	2050-74-0	mg/kg	5	ND
1,2,3-Trichlorinated Naphthalene	50402-52-3	mg/kg	5	ND
1,2,3,4-Tetrachlorinated Naphthalene	20020-02-4	mg/kg	5	ND
1,2,3,4,6-Pentachlorinated Naphthalene	67922-26-3	mg/kg	5	ND
Octa-chlorinated Naphthalene	2234-13-1	mg/kg	5	ND

## Polychlorinated Terphenyls (PCTs)

Test Method: With reference to US EPA 8082A: 2007, analysis was performed by GC-MS.

Test Item(s)	CAS No.	Unit(s)	MDL	A3
Aroclor 5432	63496-31-1	mg/kg	0.5	ND
Aroclor 5442	12642-23-8	mg/kg	0.5	ND
Aroclor 5460	11126-42-4	mg/kg	0.5	ND



Unless otherwise agreed in writing, this document is issued by the Company subject to its General Conditions of Service printed overleaf, available on request or accessible at <http://www.sgs.com/en/Terms-and-Conditions.aspx> and, for electronic format documents, subject to Terms and Conditions for Electronic Documents at <http://www.sgs.com/en/Terms-and-Conditions/Terms-e-Documents.aspx>. Attention is drawn to the limitation of liability, indemnification and jurisdiction issues defined therein. Any holder of this document is advised that information contained hereon reflects the Company's findings at the time of its intervention only and within the limits of Client's instructions, if any. The Company's sole responsibility is to its Client and this document does not exonerate parties to a transaction from exercising all their rights and obligations under the transaction documents. This document cannot be reproduced except in full, without prior written approval of the Company. Any unauthorized alteration, forgery or falsification of the content or appearance of this document is unlawful and offenders may be prosecuted to the fullest extent of the law. Unless otherwise stated the results shown in this test report refer only to the sample(s) tested.

Attention: To check the authenticity of testing / inspection report & certificate, please contact us at telephone: (86-755) 8307 1443, or email: [CN.Doccheck@sgs.com](mailto:CN.Doccheck@sgs.com)

SGS-CSTC (Shanghai) Technical Services (Shanghai) Co., Ltd.  
Testing Center-Chemical Laboratory

3<sup>rd</sup> Building, No. 889 Yishan Road Xuhui District, Shanghai China 200233  
中国·上海·徐汇区宜山路889号3号楼 邮编: 200233

t E&E (86-21) 61402553 f E&E (86-21) 64953679 www.sgsgroup.com.cn  
t HL (86-21) 61402594 f HL (86-21) 61156899 e sgs.china@sgs.com

# Test Report

No.: SHAEC23006090145

Date: May 24, 2023

Page 6 of 27

## Polyvinyl chloride (PVC)

Test Method: With reference to SGS in house method, analysis was performed by FTIR/HATR.

Test Item(s)	A3
Polyvinyl chloride (PVC)	Negative

### Notes:

(1) Negative=The sample does not contain Polyvinylchloride (PVC),Positive=The sample contains Polyvinylchloride (PVC)

## Red Phosphorus

Test Method: With reference to SGS In house method, analysis was performed by ICP-OES and Pyrolysis-GC-MS.

Test Item(s)	CAS No.	Unit(s)	MDL	A3
Red Phosphorus	7723-14-0	mg/kg	500	ND

### Notes:

(1) The testing result is based on the worst-case scenario, and confirmed by Pyrolysis-GC-MS.

## TBBP-A

Test Method: With reference to US EPA 3540C:1996, analysis was performed by GC-MS/LC-MS.

Test Item(s)	CAS No.	Unit(s)	MDL	A3
TBBP-A	79-94-7	mg/kg	10	ND

## Organic-tin compounds

Test Method: With reference to ISO 17353:2004, analysis was performed by GC-MS.

Test Item(s)	Unit(s)	MDL	A3
Dibutyl tin(DBT)	mg/kg	0.02	ND
Tributyl tin(TBT)	mg/kg	0.02	ND
Diocetyl tin(DOT)	mg/kg	0.02	ND
Tri-n-propyltin(TPT)	mg/kg	0.02	ND
Bis(tributyltin) oxide (TBTO) ◆	mg/kg	0.02	ND

### Notes:

(1) ◆ TBTO is back calculated based on the worst-case scenario of TBT.

## Perfluorooctane Sulfonates (PFOS) and its derivatives and Perfluorooctanoic Acid (PFOA) and its salts

Test Method: With reference to CEN/TS 15968:2010, analysis was performed by HPLC-MS or LC-MS/MS.



Unless otherwise agreed in writing, this document is issued by the Company subject to its General Conditions of Service printed overleaf, available on request or accessible at <http://www.sgs.com/en/Terms-and-Conditions.aspx> and, for electronic format documents, subject to Terms and Conditions for Electronic Documents at <http://www.sgs.com/en/Terms-and-Conditions/Terms-e-Documents.aspx>. Attention is drawn to the limitation of liability, indemnification and jurisdiction issues defined therein. Any holder of this document is advised that information contained hereon reflects the Company's findings at the time of its intervention only and within the limits of Client's instructions, if any. The Company's sole responsibility is to its Client and this document does not exonerate parties to a transaction from exercising all their rights and obligations under the transaction documents. This document cannot be reproduced except in full, without prior written approval of the Company. Any unauthorized alteration, forgery or falsification of the content or appearance of this document is unlawful and offenders may be prosecuted to the fullest extent of the law. Unless otherwise stated the results shown in this test report refer only to the sample(s) tested.

Attention: To check the authenticity of testing /inspection report & certificate, please contact us at telephone: (86-755) 8307 1443, or email: CN.Doccheck@sgs.com

SGS-CSTC (Shanghai) Technical Services (Shanghai) Co., Ltd.  
Testing Center-Chemical Laboratory

3<sup>rd</sup> Building, No.889 Yishan Road Xuhui District, Shanghai China 200233  
中国·上海·徐汇区宜山路889号3号楼 邮编: 200233

t E&E (86-21) 61402553 f E&E (86-21) 64953679 www.sgsgroup.com.cn  
t HL (86-21) 61402594 f HL (86-21) 61156899 e sgs.china@sgs.com

# Test Report

No.: SHAEC23006090145

Date: May 24, 2023

Page 7 of 27

Test Item(s)	CAS No.	Unit(s)	MDL	A3
PFOS and its derivatives	-	mg/kg	-	ND
Perfluorooctane Sulfonates(PFOS)*	-	mg/kg	0.010	ND
N-ethylperfluoro-1-octanesulfonamide (N-EtFOSA)	4151-50-2	mg/kg	0.010	ND
N-methylperfluoro-1-octanesulfonamide (N-MeFOSA)	31506-32-8	mg/kg	0.010	ND
2-(N-ethylperfluoro-1-octanesulfonamido)-ethanol (N-EtFOSE)	1691-99-2	mg/kg	0.010	ND
2-(N-methylperfluoro-1-octanesulfonamido)-ethanol (N-MeFOSE)	24448-09-7	mg/kg	0.010	ND
Perfluorooctane Sulfonamide (PFOSA)	754-91-6	mg/kg	0.010	ND
Perfluorooctanoic Acid (PFOA) and its salts*	-	mg/kg	0.010	ND

### Notes:

(1) Perfluorooctanoic acid (PFOA) and its salts\* including PFOA (CAS No. 335-67-1), APFO (CAS No. 3825-26-1), PFOA-Na (CAS No. 335-95-5), PFOA-K (CAS No. 2395-00-8), PFOA-Ag (CAS No. 335-93-3) and PFOA-F (CAS No. 335-66-0). The result of PFOA is used to represent PFOA and its salts.

(2) Perfluorooctane sulfonates (PFOS) and its salts\* including PFOS (CAS No. 1763-23-1), POSF(CAS No. 307-35-7), PFOS-K (CAS No. 2795-39-3), PFOS-NH<sub>4</sub> (CAS No. 29081-56-9), PFOS-N(C<sub>10</sub>H<sub>21</sub>)<sub>2</sub>(CH<sub>3</sub>)<sub>2</sub> (CAS No. 251099-16-8), PFOS-NH<sub>2</sub>(C<sub>2</sub>H<sub>4</sub>OH)<sub>2</sub> (CAS No. 70225-14-8), PFOS-Li (CAS No. 29457-72-5), PFOS-N(C<sub>2</sub>H<sub>5</sub>)<sub>4</sub> (CAS No. 56773-42-3) and PFOS-Na (CAS No. 4021-47-0). The result of PFOS is used to represent PFOS and its salts.

### Polycyclic Aromatic Hydrocarbons (PAHs)

Test Method: With reference to AfPS GS 2019:01 PAK, analysis was performed by GC-MS.

Test Item(s)	CAS No.	Unit(s)	MDL	A3
Benzo(a)pyrene(BaP)	50-32-8	mg/kg	0.1	ND
Benzo(e)pyrene(BeP)	192-97-2	mg/kg	0.1	ND
Benzo(a)anthracene(BaA)	56-55-3	mg/kg	0.1	ND
Benzo(b)Fluoranthene(BbF)	205-99-2	mg/kg	0.1	ND
Benzo(j)fluoranthene(BjF)	205-82-3	mg/kg	0.1	ND
Benzo(k)Fluoranthene(BkF)	207-08-9	mg/kg	0.1	ND
Chrysene(CHR)	218-01-9	mg/kg	0.1	ND
Dibenzo(a,h)Anthracene(DBA)	53-70-3	mg/kg	0.1	ND
Benzo(g,h,i)perylene(BPE)	191-24-2	mg/kg	0.1	ND
Indeno(1,2,3-c,d)pyrene(IPY)	193-39-5	mg/kg	0.1	ND
Phenanthrene(PHE)	85-01-8	mg/kg	0.1	ND
Pyrene(PYR)	129-00-0	mg/kg	0.1	ND
Anthracene(ANT)	120-12-7	mg/kg	0.1	ND
Fluoranthene(FLT)	206-44-0	mg/kg	0.1	ND
Sum of Phenanthrene(PHE), Pyrene(PYR), Anthracene(ANT), Fluoranthene(FLT)	-	mg/kg	-	ND
Naphthalene(NAP)	91-20-3	mg/kg	0.1	ND



Unless otherwise agreed in writing, this document is issued by the Company subject to its General Conditions of Service printed overleaf, available on request or accessible at <http://www.sgs.com/en/Terms-and-Conditions.aspx> and, for electronic format documents, subject to Terms and Conditions for Electronic Documents at <http://www.sgs.com/en/Terms-and-Conditions/Terms-e-Documents.aspx>. Attention is drawn to the limitation of liability, indemnification and jurisdiction issues defined therein. Any holder of this document is advised that information contained hereon reflects the Company's findings at the time of its intervention only and within the limits of Client's instructions, if any. The Company's sole responsibility is to its Client and this document does not exonerate parties to a transaction from exercising all their rights and obligations under the transaction documents. This document cannot be reproduced except in full, without prior written approval of the Company. Any unauthorized alteration, forgery or falsification of the content or appearance of this document is unlawful and offenders may be prosecuted to the fullest extent of the law. Unless otherwise stated the results shown in this test report refer only to the sample(s) tested.

Attention: To check the authenticity of testing /inspection report & certificate, please contact us at telephone: (86-755) 8307 1443, or email: [CN.Doccheck@sgs.com](mailto:CN.Doccheck@sgs.com)

3<sup>rd</sup> Building, No.889 Yishan Road Xuhui District, Shanghai China 200233 t E&E (86-21) 61402553 f E&E (86-21) 64953679 www.sgs.com.cn  
中国·上海·徐汇区宜山路889号3号楼 邮编: 200233 t HL (86-21) 61402594 f HL (86-21) 61156899 e [sgs.china@sgs.com](mailto:sgs.china@sgs.com)

# Test Report

No.: SHAEC23006090145

Date: May 24, 2023

Page 8 of 27

Test Item(s)	CAS No.	Unit(s)	MDL	A3
Sum of 15 PAHs	-	mg/kg	-	ND
Material Category	-	-	-	-

**Notes:**

**AfPS (German commission for Product Safety) : PAHs requirements**

Parameter	Category 1	Category 2		Category 3	
	Materials intended to be placed in the mouth, or materials coming into long-term contact with skin (more than 30s) during the intended use -in toys according to Directive 2009/48/EC or -for the use by children <sup>a,b</sup> up to 3 years of age.	Materials not covered by category 1, coming into long-term contact (more than 30s) or short-term repetitive contact <sup>c</sup> with skin during the intended or foreseeable use <sup>d</sup> .		Materials covered neither by category 1 nor by category 2, coming into short-term contact (up to 30s) with skin during the intended or foreseeable use.	
		a. use by children	b. other consumer products	a. use by children	b. other consumer products
Benzo(a)pyrene (BaP) mg/kg	< 0.2	< 0.2	< 0.5	< 0.5	< 1
Benzo(e)pyrene (BeP) mg/kg	< 0.2	< 0.2	< 0.5	< 0.5	< 1
Benzo(a)anthracene (BaA) mg/kg	< 0.2	< 0.2	< 0.5	< 0.5	< 1
Benzo(b)fluoranthene (BbF) mg/kg	< 0.2	< 0.2	< 0.5	< 0.5	< 1
Benzo(j)fluoranthene (BjF) mg/kg	< 0.2	< 0.2	< 0.5	< 0.5	< 1
Benzo(k)fluoranthene (BkF)mg/kg	< 0.2	< 0.2	< 0.5	< 0.5	< 1
Chrysene (CHR) mg/kg	< 0.2	< 0.2	< 0.5	< 0.5	< 1
Dibenzo(a,h)anthracene (DBA) mg/kg	< 0.2	< 0.2	< 0.5	< 0.5	< 1
Benzo(g,h,i)perylene (BPE) mg/kg	< 0.2	< 0.2	< 0.5	< 0.5	< 1



Unless otherwise agreed in writing, this document is issued by the Company subject to its General Conditions of Service printed overleaf, available on request or accessible at <http://www.sgs.com/en/Terms-and-Conditions.aspx> and, for electronic format documents, subject to Terms and Conditions for Electronic Documents at <http://www.sgs.com/en/Terms-and-Conditions/Terms-e-Documents.aspx>. Attention is drawn to the limitation of liability, indemnification and jurisdiction issues defined therein. Any holder of this document is advised that information contained hereon reflects the Company's findings at the time of its intervention only and within the limits of Client's instructions, if any. The Company's sole responsibility is to its Client and this document does not exonerate parties to a transaction from exercising all their rights and obligations under the transaction documents. This document cannot be reproduced except in full, without prior written approval of the Company. Any unauthorized alteration, forgery or falsification of the content or appearance of this document is unlawful and offenders may be prosecuted to the fullest extent of the law. Unless otherwise stated the results shown in this test report refer only to the sample(s) tested.

Attention: To check the authenticity of testing /inspection report & certificate, please contact us at telephone: (86-755) 8307 1443, or email: [CN.Doccheck@sgs.com](mailto:CN.Doccheck@sgs.com)

SGS-CSTC Standards Technical Services (Shanghai) Co., Ltd.  
Testing Center-Chemical Laboratory

3<sup>rd</sup> Building, No.889 Yishan Road Xuhui District, Shanghai China 200233 t E&E (86-21) 61402553 f E&E (86-21) 64953679 www.sgs.com.cn  
中国·上海·徐汇区宜山路889号3号楼 邮编: 200233 t HL (86-21) 61402594 f HL (86-21) 61156899 e sgs.china@sgs.com



# Test Report

No.: SHAEC23006090145

Date: May 24, 2023

Page 9 of 27

Indeno(1,2,3-cd)pyrene (IPY) mg/kg	< 0.2	< 0.2	< 0.5	< 0.5	< 1
Phenanthrene (PHE), pyrene (PYR), anthracene (ANT), fluoranthene (FLT), mg/kg	< 1 Sum	< 5 Sum	< 10 Sum	< 20 Sum	< 50 Sum
Naphthalene (NAP) mg/kg	< 1	< 2	< 10		
<b>Sum of 15 PAHs</b>	<1	< 5	< 10	< 20	< 50

**Notes:**

- <sup>a</sup> A “Child” is legally defined as a person before reaching the age of 14 years.
- <sup>b</sup> Use by children includes both active and passive contact by children.
- <sup>c</sup> Definition “short-term repetitive contact” taken from REACH Annex XVII entry 50 amendment (Regulation (EC) No.1272/2013)
- <sup>d</sup> According to the definition of the German Product Safety Act (ProdSG) (chapter 1 Article 2 No. 28) “foreseeable use” shall mean the use of a product in a manner that the person placing it on the market, has not intended, but which could be reasonably foreseeable.

**Remark:**

The German committee on Product Safety (AfPS) published a new PAHs document (AfPS GS 2019:01 PAK) on April 10, 2020, which will be binding for the issue of GS mark certificate from July 1, 2020.

Unless otherwise stated, the decision rule for conformity reporting is based on Binary Statement for Simple Acceptance Rule (w=0) stated in ILAC-G8:09/2019.



Unless otherwise agreed in writing, this document is issued by the Company subject to its General Conditions of Service printed overleaf, available on request or accessible at <http://www.sgs.com/en/Terms-and-Conditions.aspx> and, for electronic format documents, subject to Terms and Conditions for Electronic Documents at <http://www.sgs.com/en/Terms-and-Conditions/Terms-e-Documents.aspx>. Attention is drawn to the limitation of liability, indemnification and jurisdiction issues defined therein. Any holder of this document is advised that information contained hereon reflects the Company's findings at the time of its intervention only and within the limits of Client's instructions, if any. The Company's sole responsibility is to its Client and this document does not exonerate parties to a transaction from exercising all their rights and obligations under the transaction documents. This document cannot be reproduced except in full, without prior written approval of the Company. Any unauthorized alteration, forgery or falsification of the content or appearance of this document is unlawful and offenders may be prosecuted to the fullest extent of the law. Unless otherwise stated the results shown in this test report refer only to the sample(s) tested.

Attention: To check the authenticity of testing /inspection report & certificate, please contact us at telephone: (86-755) 8307 1443, or email: [CN.Doccheck@sgs.com](mailto:CN.Doccheck@sgs.com)

3<sup>rd</sup> Building, No.889 Yishan Road Xuhui District, Shanghai China 200233 t E&E (86-21) 61402553 f E&E (86-21) 64953679 www.sgsgroup.com.cn  
 中国·上海·徐汇区宜山路889号3号楼 邮编: 200233 t HL (86-21) 61402594 f HL (86-21) 61156899 e [sgs.china@sgs.com](mailto:sgs.china@sgs.com)

### Elements Testing Flow Chart

These samples were dissolved totally by pre-conditioning method according to below flow chart.

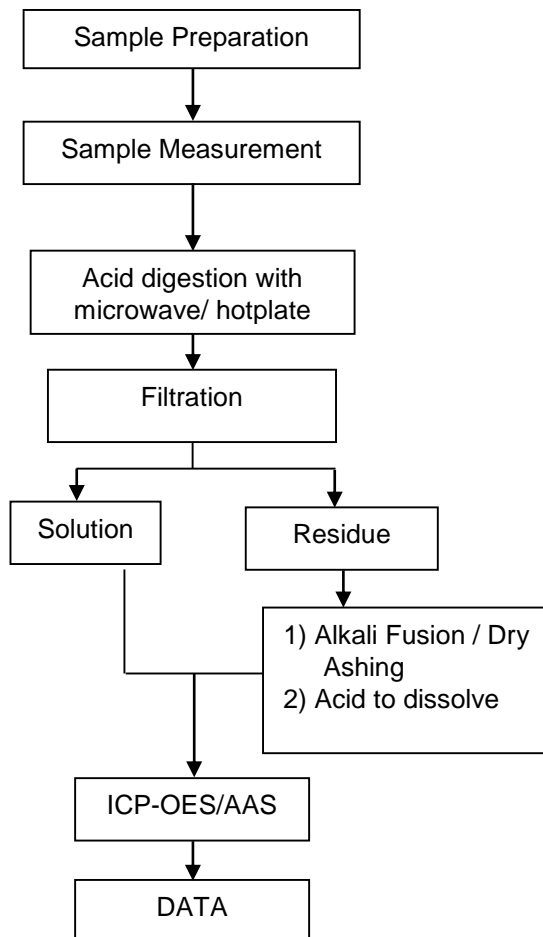

Unless otherwise agreed in writing, this document is issued by the Company subject to its General Conditions of Service printed overleaf, available on request or accessible at <http://www.sgs.com/en/Terms-and-Conditions.aspx> and, for electronic format documents, subject to Terms and Conditions for Electronic Documents at <http://www.sgs.com/en/Terms-and-Conditions/Terms-e-Documents.aspx>. Attention is drawn to the limitation of liability, indemnification and jurisdiction issues defined therein. Any holder of this document is advised that information contained hereon reflects the Company's findings at the time of its intervention only and within the limits of Client's instructions, if any. The Company's sole responsibility is to its Client and this document does not exonerate parties to a transaction from exercising all their rights and obligations under the transaction documents. This document cannot be reproduced except in full, without prior written approval of the Company. Any unauthorized alteration, forgery or falsification of the content or appearance of this document is unlawful and offenders may be prosecuted to the fullest extent of the law. Unless otherwise stated the results shown in this test report refer only to the sample(s) tested.

Attention: To check the authenticity of testing / inspection report & certificate, please contact us at telephone: (86-755) 8307 1443, or email: [CN.Doccheck@sgs.com](mailto:CN.Doccheck@sgs.com)

SGS-CSST (Shanghai) Co., Ltd.  
Testing Center-Chemical Laboratory

3<sup>rd</sup> Building, No. 889 Yishan Road Xuhui District, Shanghai China 200233  
中国·上海·徐汇区宜山路889号3号楼 邮编: 200233

t E&E (86-21) 61402553 f E&E (86-21) 64953679 www.sgs.com.cn  
t HL (86-21) 61402594 f HL (86-21) 61156899 e sgs.china@sgs.com

ATTACHMENTS

## Hexavalent Chromium (Cr(VI)) Testing Flow Chart

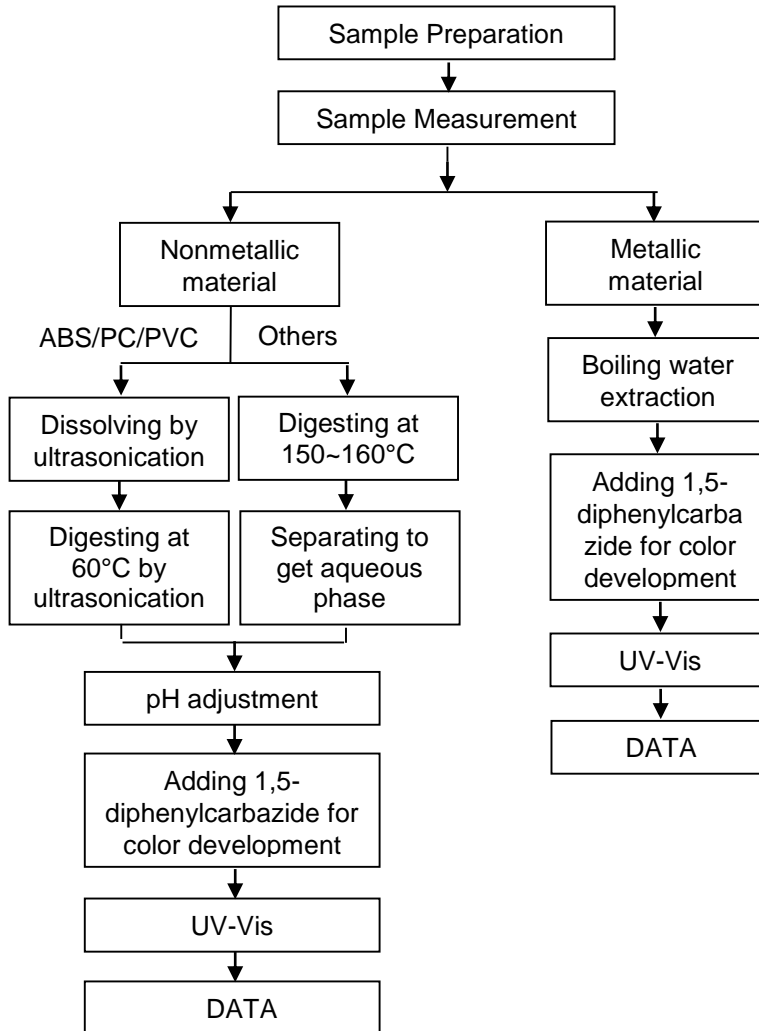

**PBBs/PBDEs Testing Flow Chart**

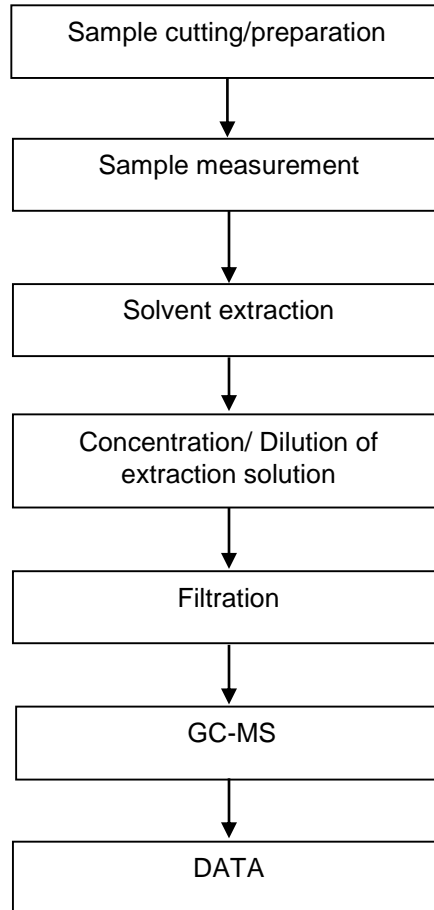

SGS-CSTC Standards Technical Services (Shanghai) Co., Ltd.  
Testing Center-Chemical Laboratory

Unless otherwise agreed in writing, this document is issued by the Company subject to its General Conditions of Service printed overleaf, available on request or accessible at <http://www.sgs.com/en/Terms-and-Conditions.aspx> and, for electronic format documents, subject to Terms and Conditions for Electronic Documents at <http://www.sgs.com/en/Terms-and-Conditions/Terms-e-Documents.aspx>. Attention is drawn to the limitation of liability, indemnification and jurisdiction issues defined therein. Any holder of this document is advised that information contained hereon reflects the Company's findings at the time of its intervention only and within the limits of Client's instructions, if any. The Company's sole responsibility is to its Client and this document does not exonerate parties to a transaction from exercising all their rights and obligations under the transaction documents. This document cannot be reproduced except in full, without prior written approval of the Company. Any unauthorized alteration, forgery or falsification of the content or appearance of this document is unlawful and offenders may be prosecuted to the fullest extent of the law. Unless otherwise stated the results shown in this test report refer only to the sample(s) tested.

Attention: To check the authenticity of testing /inspection report & certificate, please contact us at telephone: (86-755) 8307 1443, or email: [CN.Doccheck@sgs.com](mailto:CN.Doccheck@sgs.com)

3<sup>rd</sup> Building, No.889 Yishan Road Xuhui District, Shanghai China 200233 t E&E (86-21) 61402553 f E&E (86-21) 64953679 www.sgsgroup.com.cn  
中国·上海·徐汇区宜山路889号3号楼 邮编: 200233 t HL (86-21) 61402594 f HL (86-21) 61156899 e sgs.china@sgs.com

**Phthalates Testing Flow Chart**

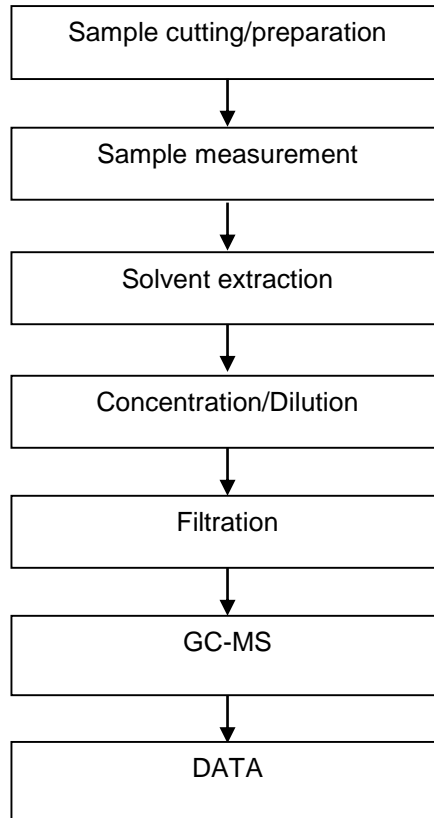

Unless otherwise agreed in writing, this document is issued by the Company subject to its General Conditions of Service printed overleaf, available on request or accessible at <http://www.sgs.com/en/Terms-and-Conditions.aspx> and, for electronic format documents, subject to Terms and Conditions for Electronic Documents at <http://www.sgs.com/en/Terms-and-Conditions/Terms-e-Documents.aspx>. Attention is drawn to the limitation of liability, indemnification and jurisdiction issues defined therein. Any holder of this document is advised that information contained hereon reflects the Company's findings at the time of its intervention only and within the limits of Client's instructions, if any. The Company's sole responsibility is to its Client and this document does not exonerate parties to a transaction from exercising all their rights and obligations under the transaction documents. This document cannot be reproduced except in full, without prior written approval of the Company. Any unauthorized alteration, forgery or falsification of the content or appearance of this document is unlawful and offenders may be prosecuted to the fullest extent of the law. Unless otherwise stated the results shown in this test report refer only to the sample(s) tested.

Attention: To check the authenticity of testing / inspection report & certificate, please contact us at telephone: (86-755) 8307 1443, or email: [CN.Doccheck@sgs.com](mailto:CN.Doccheck@sgs.com)

**Chlorinated Paraffin Testing Flow Chart**

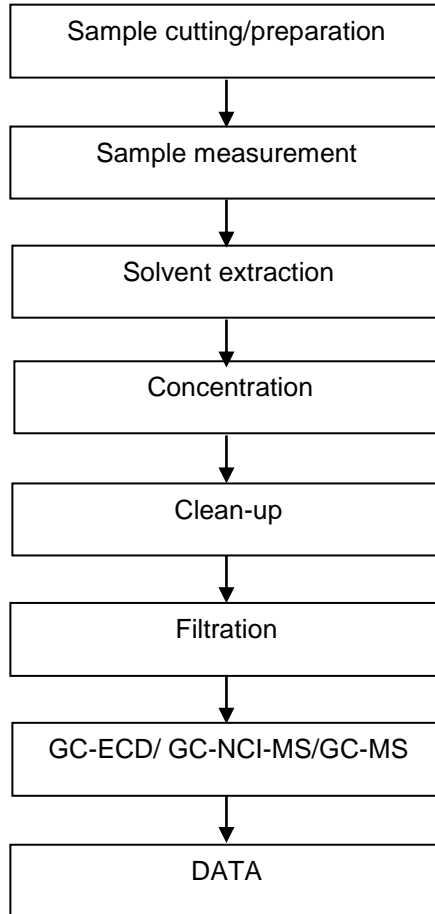

SGS-CSST (Shanghai) Co., Ltd.  
Testing Center-Chemical Laboratory

Unless otherwise agreed in writing, this document is issued by the Company subject to its General Conditions of Service printed overleaf, available on request or accessible at <http://www.sgs.com/en/Terms-and-Conditions.aspx> and, for electronic format documents, subject to Terms and Conditions for Electronic Documents at <http://www.sgs.com/en/Terms-and-Conditions/Terms-e-Documents.aspx>. Attention is drawn to the limitation of liability, indemnification and jurisdiction issues defined therein. Any holder of this document is advised that information contained hereon reflects the Company's findings at the time of its intervention only and within the limits of Client's instructions, if any. The Company's sole responsibility is to its Client and this document does not exonerate parties to a transaction from exercising all their rights and obligations under the transaction documents. This document cannot be reproduced except in full, without prior written approval of the Company. Any unauthorized alteration, forgery or falsification of the content or appearance of this document is unlawful and offenders may be prosecuted to the fullest extent of the law. Unless otherwise stated the results shown in this test report refer only to the sample(s) tested.

Attention: To check the authenticity of testing /inspection report & certificate, please contact us at telephone: (86-755) 8307 1443, or email: [CN.Doccheck@sgs.com](mailto:CN.Doccheck@sgs.com)

3<sup>rd</sup> Building, No.889 Yishan Road Xuhui District, Shanghai China 200233 t E&E (86-21) 61402553 f E&E (86-21) 64953679 www.sgsgroup.com.cn  
中国·上海·徐汇区宜山路889号3号楼 邮编: 200233 t HL (86-21) 61402594 f HL (86-21) 61156899 e sgs.china@sgs.com

### Elements Testing Flow Chart

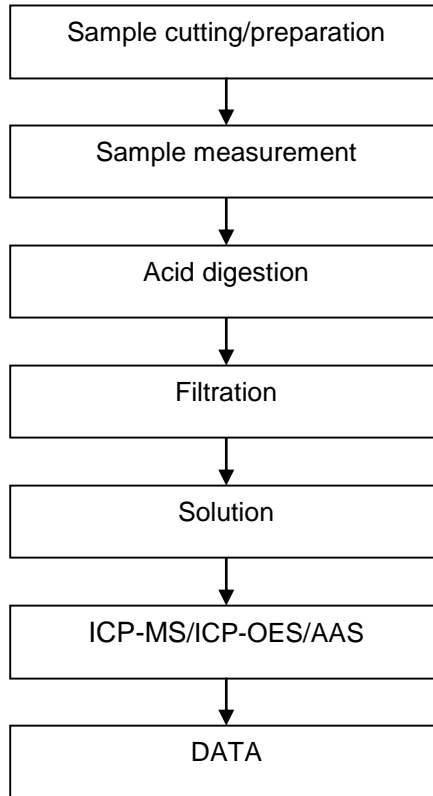

SGS-CSST (Shanghai) Co., Ltd.  
Testing Center-Chemical Laboratory

Unless otherwise agreed in writing, this document is issued by the Company subject to its General Conditions of Service printed overleaf, available on request or accessible at <http://www.sgs.com/en/Terms-and-Conditions.aspx> and, for electronic format documents, subject to Terms and Conditions for Electronic Documents at <http://www.sgs.com/en/Terms-and-Conditions/Terms-e-Documents.aspx>. Attention is drawn to the limitation of liability, indemnification and jurisdiction issues defined therein. Any holder of this document is advised that information contained hereon reflects the Company's findings at the time of its intervention only and within the limits of Client's instructions, if any. The Company's sole responsibility is to its Client and this document does not exonerate parties to a transaction from exercising all their rights and obligations under the transaction documents. This document cannot be reproduced except in full, without prior written approval of the Company. Any unauthorized alteration, forgery or falsification of the content or appearance of this document is unlawful and offenders may be prosecuted to the fullest extent of the law. Unless otherwise stated the results shown in this test report refer only to the sample(s) tested.

Attention: To check the authenticity of testing /inspection report & certificate, please contact us at telephone: (86-755) 8307 1443, or email: [CN.Doccheck@sgs.com](mailto:CN.Doccheck@sgs.com)

3<sup>rd</sup> Building, No. 889 Yishan Road Xuhui District, Shanghai China 200233 t E&E (86-21) 61402553 f E&E (86-21) 64953679 www.sgs.com.cn  
中国·上海·徐汇区宜山路889号3号楼 邮编: 200233 t HL (86-21) 61402594 f HL (86-21) 61156899 e sgs.china@sgs.com

## Halogen Testing Flow Chart

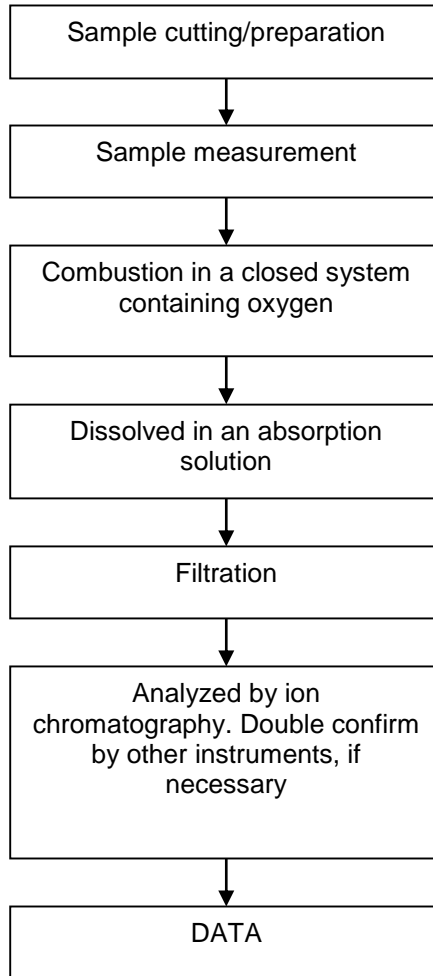



### HBCDD Testing Flow Chart

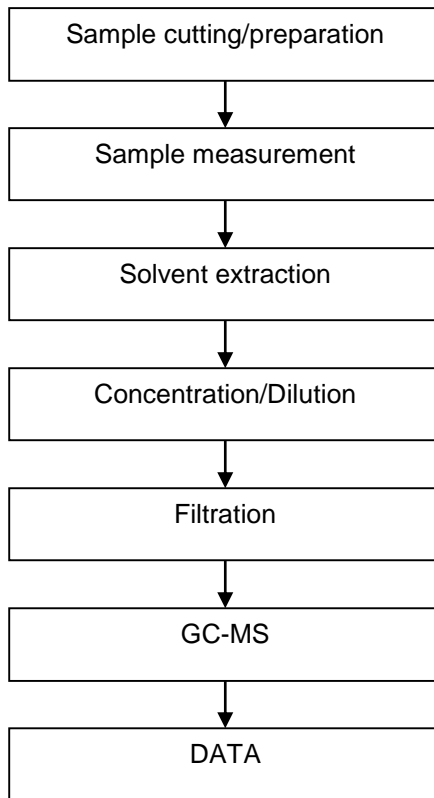

SGS-CSSTC (Shanghai) Inspection & Testing Services Co., Ltd.  
Testing Center-Chemical Laboratory

Unless otherwise agreed in writing, this document is issued by the Company subject to its General Conditions of Service printed overleaf, available on request or accessible at <http://www.sgs.com/en/Terms-and-Conditions.aspx> and, for electronic format documents, subject to Terms and Conditions for Electronic Documents at <http://www.sgs.com/en/Terms-and-Conditions/Terms-e-Documents.aspx>. Attention is drawn to the limitation of liability, indemnification and jurisdiction issues defined therein. Any holder of this document is advised that information contained hereon reflects the Company's findings at the time of its intervention only and within the limits of Client's instructions, if any. The Company's sole responsibility is to its Client and this document does not exonerate parties to a transaction from exercising all their rights and obligations under the transaction documents. This document cannot be reproduced except in full, without prior written approval of the Company. Any unauthorized alteration, forgery or falsification of the content or appearance of this document is unlawful and offenders may be prosecuted to the fullest extent of the law. Unless otherwise stated the results shown in this test report refer only to the sample(s) tested.

Attention: To check the authenticity of testing /inspection report & certificate, please contact us at telephone: (86-755) 8307 1443, or email: [CN.Doccheck@sgs.com](mailto:CN.Doccheck@sgs.com)

3<sup>rd</sup> Building, No.889 Yishan Road Xuhui District, Shanghai China 200233 t E&E (86-21) 61402553 f E&E (86-21) 64953679 www.sgsgroup.com.cn  
中国·上海·徐汇区宜山路889号3号楼 邮编: 200233 t HL (86-21) 61402594 f HL (86-21) 61156899 e sgs.china@sgs.com

### PCB Testing Flow Chart

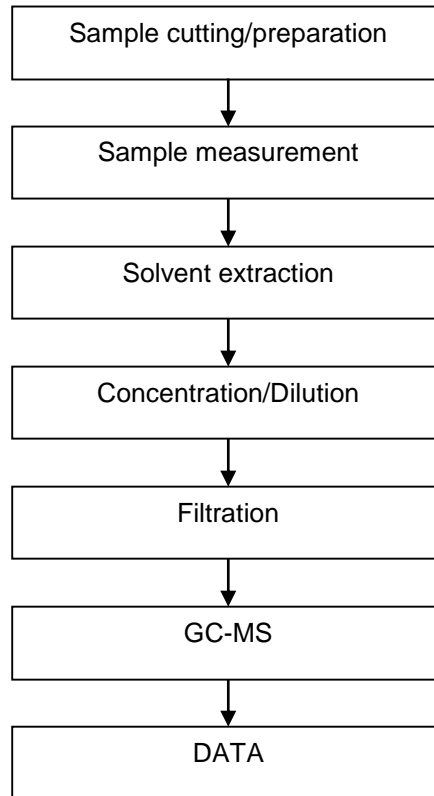

### PCN Testing Flow Chart

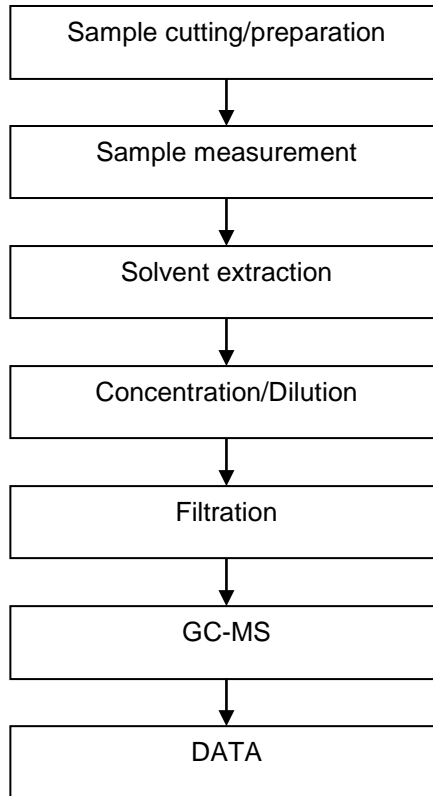

SGS-CSST (Shanghai) Co., Ltd.  
Testing Center-Chemical Laboratory

Unless otherwise agreed in writing, this document is issued by the Company subject to its General Conditions of Service printed overleaf, available on request or accessible at <http://www.sgs.com/en/Terms-and-Conditions.aspx> and, for electronic format documents, subject to Terms and Conditions for Electronic Documents at <http://www.sgs.com/en/Terms-and-Conditions/Terms-e-Documents.aspx>. Attention is drawn to the limitation of liability, indemnification and jurisdiction issues defined therein. Any holder of this document is advised that information contained hereon reflects the Company's findings at the time of its intervention only and within the limits of Client's instructions, if any. The Company's sole responsibility is to its Client and this document does not exonerate parties to a transaction from exercising all their rights and obligations under the transaction documents. This document cannot be reproduced except in full, without prior written approval of the Company. Any unauthorized alteration, forgery or falsification of the content or appearance of this document is unlawful and offenders may be prosecuted to the fullest extent of the law. Unless otherwise stated the results shown in this test report refer only to the sample(s) tested.

Attention: To check the authenticity of testing /inspection report & certificate, please contact us at telephone: (86-755) 8307 1443, or email: [CN.Doccheck@sgs.com](mailto:CN.Doccheck@sgs.com)

3<sup>rd</sup> Building, No.889 Yishan Road Xuhui District, Shanghai China 200233 t E&E (86-21) 61402553 f E&E (86-21) 64953679 www.sgsgroup.com.cn  
中国·上海·徐汇区宜山路889号3号楼 邮编: 200233 t HL (86-21) 61402594 f HL (86-21) 61156899 e sgs.china@sgs.com

### PCT Testing Flow Chart

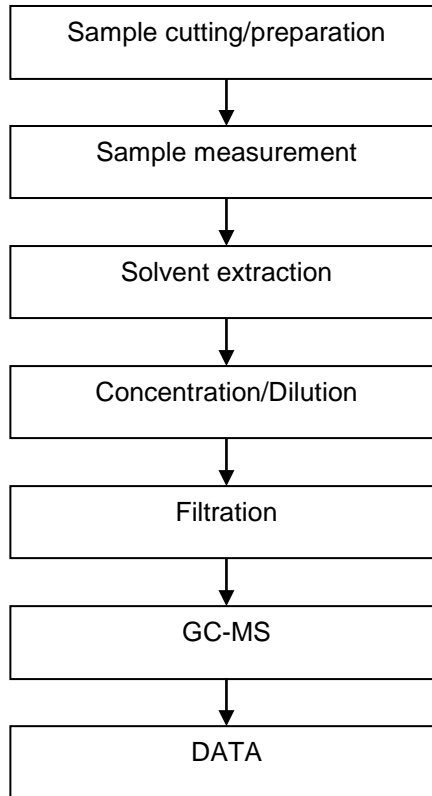

SGS-CSST (Shanghai) Technical Services Co., Ltd.  
Testing Center-Chemical Laboratory

Unless otherwise agreed in writing, this document is issued by the Company subject to its General Conditions of Service printed overleaf, available on request or accessible at <http://www.sgs.com/en/Terms-and-Conditions.aspx> and, for electronic format documents, subject to Terms and Conditions for Electronic Documents at <http://www.sgs.com/en/Terms-and-Conditions/Terms-e-Documents.aspx>. Attention is drawn to the limitation of liability, indemnification and jurisdiction issues defined therein. Any holder of this document is advised that information contained hereon reflects the Company's findings at the time of its intervention only and within the limits of Client's instructions, if any. The Company's sole responsibility is to its Client and this document does not exonerate parties to a transaction from exercising all their rights and obligations under the transaction documents. This document cannot be reproduced except in full, without prior written approval of the Company. Any unauthorized alteration, forgery or falsification of the content or appearance of this document is unlawful and offenders may be prosecuted to the fullest extent of the law. Unless otherwise stated the results shown in this test report refer only to the sample(s) tested.

Attention: To check the authenticity of testing /inspection report & certificate, please contact us at telephone: (86-755) 8307 1443, or email: [CN.Doccheck@sgs.com](mailto:CN.Doccheck@sgs.com)

3<sup>rd</sup> Building, No.889 Yishan Road Xuhui District, Shanghai China 200233 t E&E (86-21) 61402553 f E&E (86-21) 64953679 www.sgsgroup.com.cn  
中国·上海·徐汇区宜山路889号3号楼 邮编: 200233 t HL (86-21) 61402594 f HL (86-21) 61156899 e sgs.china@sgs.com

### PVC Testing Flow Chart

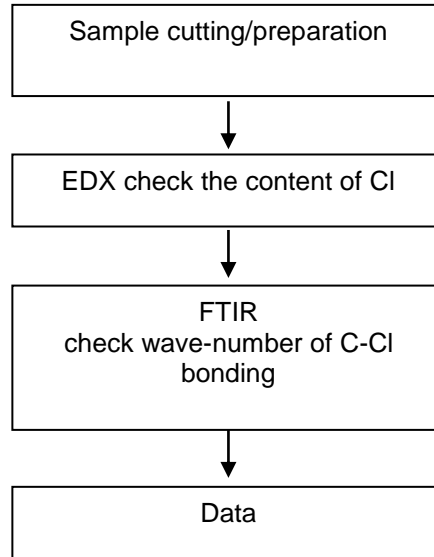

SGS-CSTC Standards Technical Services (Shanghai) Co., Ltd.  
Testing Center-Chemical Laboratory

Unless otherwise agreed in writing, this document is issued by the Company subject to its General Conditions of Service printed overleaf, available on request or accessible at <http://www.sgs.com/en/Terms-and-Conditions.aspx> and, for electronic format documents, subject to Terms and Conditions for Electronic Documents at <http://www.sgs.com/en/Terms-and-Conditions/Terms-e-Documents.aspx>. Attention is drawn to the limitation of liability, indemnification and jurisdiction issues defined therein. Any holder of this document is advised that information contained hereon reflects the Company's findings at the time of its intervention only and within the limits of Client's instructions, if any. The Company's sole responsibility is to its Client and this document does not exonerate parties to a transaction from exercising all their rights and obligations under the transaction documents. This document cannot be reproduced except in full, without prior written approval of the Company. Any unauthorized alteration, forgery or falsification of the content or appearance of this document is unlawful and offenders may be prosecuted to the fullest extent of the law. Unless otherwise stated the results shown in this test report refer only to the sample(s) tested.

Attention: To check the authenticity of testing /inspection report & certificate, please contact us at telephone: (86-755) 8307 1443, or email: [CN.Doccheck@sgs.com](mailto:CN.Doccheck@sgs.com)

3<sup>rd</sup> Building, No. 889 Yishan Road Xuhui District, Shanghai China 200233 t E&E (86-21) 61402553 f E&E (86-21) 64953679 www.sgs.com.cn  
中国·上海·徐汇区宜山路889号3号楼 邮编: 200233 t HL (86-21) 61402594 f HL (86-21) 61156899 e [sgs.china@sgs.com](mailto:sgs.china@sgs.com)

## Red Phosphorus Testing Flow Chart

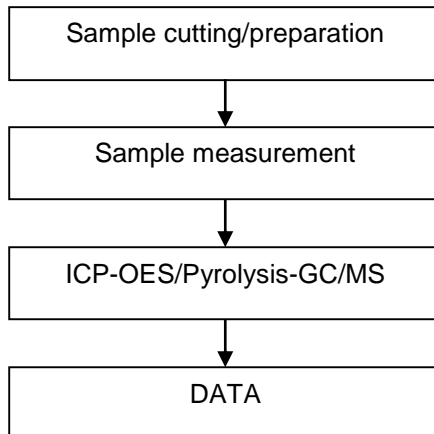

### TBBP-A Testing Flow Chart

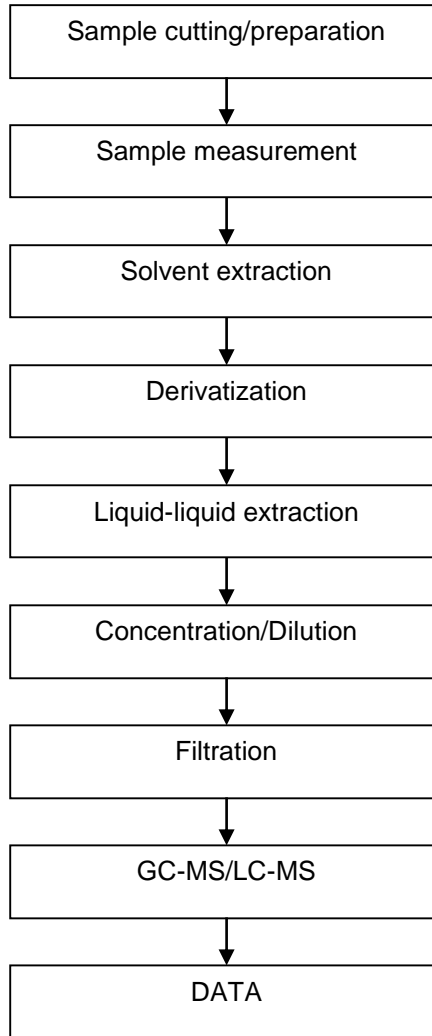

SGS-CSTC Standards Technical Services (Shanghai) Co., Ltd.  
Testing Center-Chemical Laboratory

Unless otherwise agreed in writing, this document is issued by the Company subject to its General Conditions of Service printed overleaf, available on request or accessible at <http://www.sgs.com/en/Terms-and-Conditions.aspx> and, for electronic format documents, subject to Terms and Conditions for Electronic Documents at <http://www.sgs.com/en/Terms-and-Conditions/Terms-e-Documents.aspx>. Attention is drawn to the limitation of liability, indemnification and jurisdiction issues defined therein. Any holder of this document is advised that information contained hereon reflects the Company's findings at the time of its intervention only and within the limits of Client's instructions, if any. The Company's sole responsibility is to its Client and this document does not exonerate parties to a transaction from exercising all their rights and obligations under the transaction documents. This document cannot be reproduced except in full, without prior written approval of the Company. Any unauthorized alteration, forgery or falsification of the content or appearance of this document is unlawful and offenders may be prosecuted to the fullest extent of the law. Unless otherwise stated the results shown in this test report refer only to the sample(s) tested.

Attention: To check the authenticity of testing /inspection report & certificate, please contact us at telephone: (86-755) 8307 1443, or email: [CN.Doccheck@sgs.com](mailto:CN.Doccheck@sgs.com)

3<sup>rd</sup> Building, No. 889 Yishan Road Xuhui District, Shanghai China 200233 t E&E (86-21) 61402553 f E&E (86-21) 64953679 www.sgsgroup.com.cn  
中国·上海·徐汇区宜山路889号3号楼 邮编: 200233 t HL (86-21) 61402594 f HL (86-21) 61156899 e sgs.china@sgs.com

### Organotin Testing Flow Chart

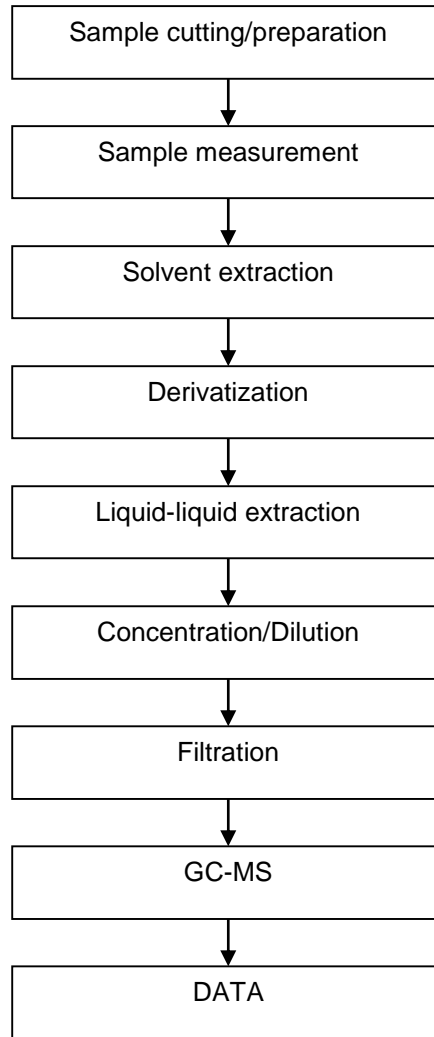

SGS-CSTC Standards Technical Services (Shanghai) Co., Ltd.  
Testing Center-Chemical Laboratory

Unless otherwise agreed in writing, this document is issued by the Company subject to its General Conditions of Service printed overleaf, available on request or accessible at <http://www.sgs.com/en/Terms-and-Conditions.aspx> and, for electronic format documents, subject to Terms and Conditions for Electronic Documents at <http://www.sgs.com/en/Terms-and-Conditions/Terms-e-Documents.aspx>. Attention is drawn to the limitation of liability, indemnification and jurisdiction issues defined therein. Any holder of this document is advised that information contained hereon reflects the Company's findings at the time of its intervention only and within the limits of Client's instructions, if any. The Company's sole responsibility is to its Client and this document does not exonerate parties to a transaction from exercising all their rights and obligations under the transaction documents. This document cannot be reproduced except in full, without prior written approval of the Company. Any unauthorized alteration, forgery or falsification of the content or appearance of this document is unlawful and offenders may be prosecuted to the fullest extent of the law. Unless otherwise stated the results shown in this test report refer only to the sample(s) tested.

Attention: To check the authenticity of testing /inspection report & certificate, please contact us at telephone: (86-755) 8307 1443, or email: [CN.Doccheck@sgs.com](mailto:CN.Doccheck@sgs.com)

3<sup>rd</sup> Building, No.889 Yishan Road Xuhui District, Shanghai China 200233 t E&E (86-21) 61402553 f E&E (86-21) 64953679 www.sgs.com.cn  
中国·上海·徐汇区宜山路889号3号楼 邮编: 200233 t HL (86-21) 61402594 f HL (86-21) 61156899 e sgs.china@sgs.com



## PFASs/ PFOS/PFOA Testing Flow Chart

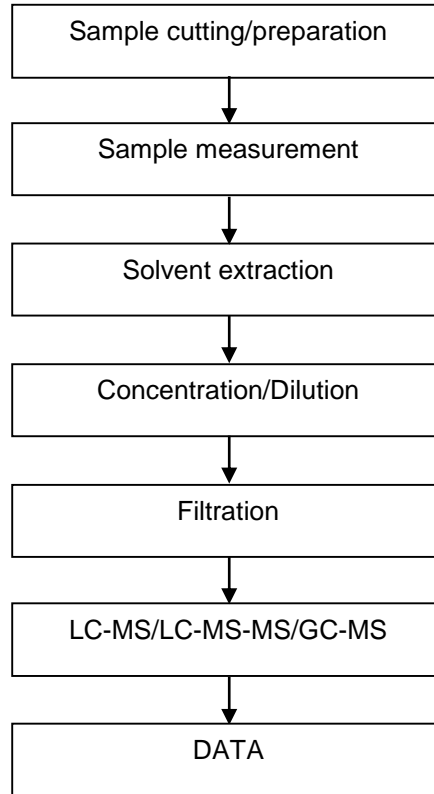

### PAHs Testing Flow Chart

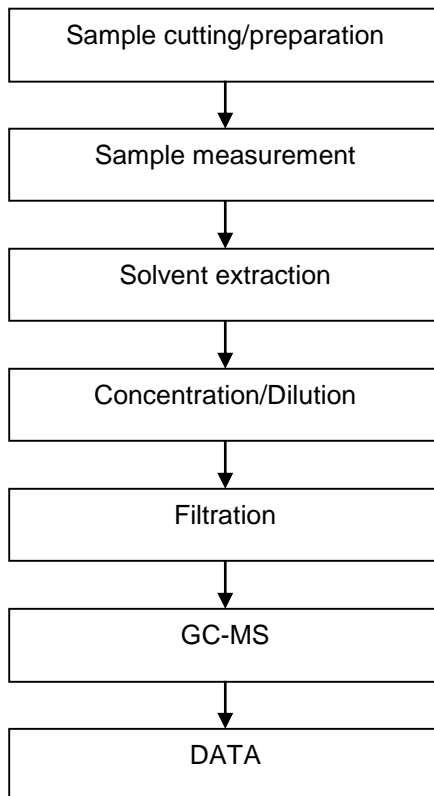

SGS-CSST (Shanghai) Co., Ltd.  
Testing Center-Chemical Laboratory

Unless otherwise agreed in writing, this document is issued by the Company subject to its General Conditions of Service printed overleaf, available on request or accessible at <http://www.sgs.com/en/Terms-and-Conditions.aspx> and, for electronic format documents, subject to Terms and Conditions for Electronic Documents at <http://www.sgs.com/en/Terms-and-Conditions/Terms-e-Documents.aspx>. Attention is drawn to the limitation of liability, indemnification and jurisdiction issues defined therein. Any holder of this document is advised that information contained hereon reflects the Company's findings at the time of its intervention only and within the limits of Client's instructions, if any. The Company's sole responsibility is to its Client and this document does not exonerate parties to a transaction from exercising all their rights and obligations under the transaction documents. This document cannot be reproduced except in full, without prior written approval of the Company. Any unauthorized alteration, forgery or falsification of the content or appearance of this document is unlawful and offenders may be prosecuted to the fullest extent of the law. Unless otherwise stated the results shown in this test report refer only to the sample(s) tested.

Attention: To check the authenticity of testing /inspection report & certificate, please contact us at telephone: (86-755) 8307 1443, or email: [CN.Doccheck@sgs.com](mailto:CN.Doccheck@sgs.com)

3<sup>rd</sup> Building, No. 889 Yishan Road Xuhui District, Shanghai China 200233 t E&E (86-21) 61402553 f E&E (86-21) 64953679 www.sgsgroup.com.cn  
中国·上海·徐汇区宜山路889号3号楼 邮编: 200233 t HL (86-21) 61402594 f HL (86-21) 61156899 e [sgs.china@sgs.com](mailto:sgs.china@sgs.com)

## Test Report

No.: SHAEC23006090145

Date: May 24, 2023

Page 27 of 27

Sample Photo:

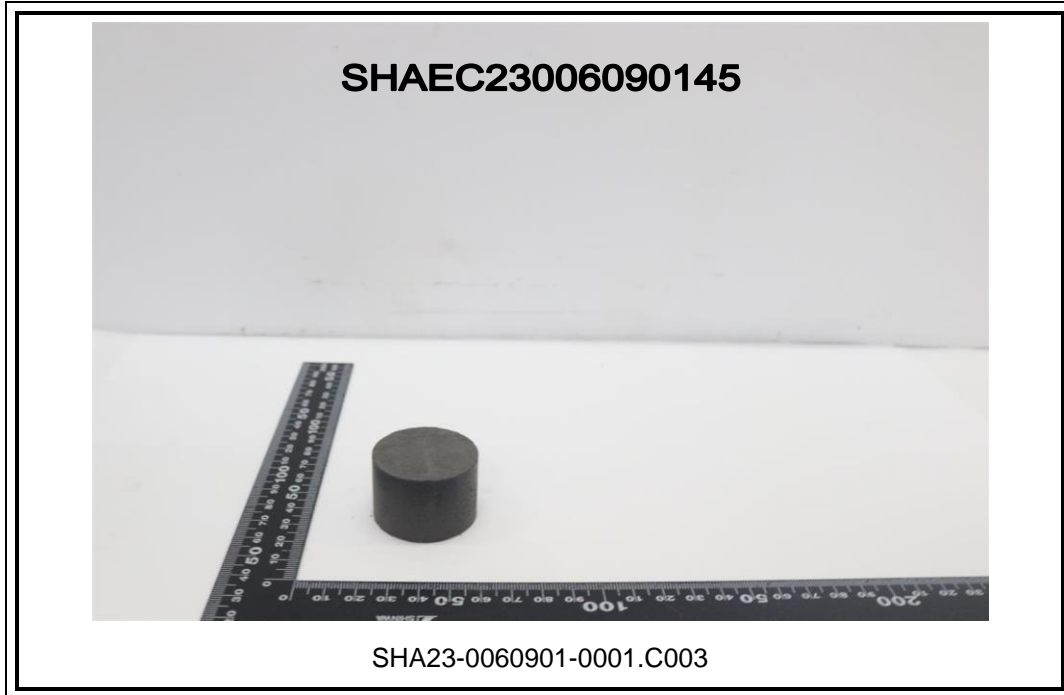

SGS authenticate the photo on original report only  
\*\*\* End of Report \*\*\*



SGS-CSTC (Shanghai) Technical Services (Shanghai) Co., Ltd.  
Testing Center-Chemical Laboratory

Unless otherwise agreed in writing, this document is issued by the Company subject to its General Conditions of Service printed overleaf, available on request or accessible at <http://www.sgs.com/en/Terms-and-Conditions.aspx> and, for electronic format documents, subject to Terms and Conditions for Electronic Documents at <http://www.sgs.com/en/Terms-and-Conditions/Terms-e-Documents.aspx>. Attention is drawn to the limitation of liability, indemnification and jurisdiction issues defined therein. Any holder of this document is advised that information contained hereon reflects the Company's findings at the time of its intervention only and within the limits of Client's instructions, if any. The Company's sole responsibility is to its Client and this document does not exonerate parties to a transaction from exercising all their rights and obligations under the transaction documents. This document cannot be reproduced except in full, without prior written approval of the Company. Any unauthorized alteration, forgery or falsification of the content or appearance of this document is unlawful and offenders may be prosecuted to the fullest extent of the law. Unless otherwise stated the results shown in this test report refer only to the sample(s) tested.

Attention: To check the authenticity of testing / inspection report & certificate, please contact us at telephone: (86-755) 8307 1443, or email: [CN.Doccheck@sgs.com](mailto:CN.Doccheck@sgs.com)

3<sup>rd</sup> Building, No. 889 Yishan Road Xuhui District, Shanghai China 200233 t E&E (86-21) 61402553 f E&E (86-21) 64953679 www.sgsgroup.com.cn  
中国·上海·徐汇区宜山路889号3号楼 邮编: 200233 t HL (86-21) 61402594 f HL (86-21) 61156899 e [sgs.china@sgs.com](mailto:sgs.china@sgs.com)