

## Test Report

No.: SHAEC23000646729\_1

Date: May 06, 2023

Page 1 of 25

Client Name: CHANG CHUN PLASTICS CO.,LTD 、 CHANG CHUN SB(CHANG SHU)CO.,LTD

Client Address: NO.8,CHUNG HWA ROAD,HSINCHU INDUSTRIAL DISTRICT,TAIWAN、 CHANGCHUN RD.,RIVERSIDE INDUSTRIAL PARK,CHANGSHU ECONOMIC DEVELOPMENT ZONE,JIANGSU,CHINA

Sample Name: Epoxy Molding Compound

Client Ref. Information: EME-E110G、 EME-E115、 EME-E120G、 EME-E190、 EG-200、 EME-E125、 EME-E210、 EME-E220、 EME-E280、 ER110、 ER120、 EME-E110G TYPE B、 EME-E110G TYPE H-3、 EME-E110G TYPE H-1、 EME-E110G TYPE H-2、 EME-E110G TYPE H、 EME-E190 TYPE M、 EME-E210 TYPE ST-1、 EME-E210 TYPE ST、 EME-E220 TYPE H、 EME-E220 TYPE H-1、 EG-200 TYPE (+)、 EME-E125 TYPE H、 EME-E115 TYPE D6、 EME-E115 TYPE D6-1、 EME-E115 TYPE ST、 EME-E115 TYPE MH、 EME-E115H、 EME-E115 TYPE H、 EME-E115 TYPE E、 EME-E125 TYPE J、 EME-E125 TYPE E、 EME-E125 TYPE E-1、 EME-E125 TYPE M、 EME-E110G TYPE ST、 EME-E110G TYPE C、 EME-E110G TYPE H-4、 EME-E110G TYPE A、 EME-E190M、 EME-E120G TYPE (+)、 EME-E125 TYPE ST、 EME-E125 TYPE JH、 EME-E110G TYPE K、 EME-E115 TYPE D6-3、 EME-E115 TYPE H-1、 EME-E115 TYPE ST-4、 EME-E210ST、 EME-E220 TYPE H-2、 EME-E115 TYPE RG-2

The above sample(s) and information were provided by the client.

**THIS REPORT IS TO SUPERSEDE TEST REPORT NO.SHAEC23000646729, DATE: Feb 07, 2023.**

SGS Job No.: SP23-001470  
Sample Receiving Date: Jan 20, 2023  
Testing Period: Jan 20, 2023 ~ Feb 02, 2023  
Test Requested: Select test(s) as requested by the client.  
Test Method(s): Please refer to next page(s).  
Test Result(s): Please refer to next page(s).

Signed for and on behalf of  
SGS-CSTC Standards Technical Services (Shanghai) Co., Ltd.

*Carol Luo*

Carol Luo  
Approved Signatory

scan to see the report



B3AF31BB



Unless otherwise agreed in writing, this document is issued by the Company subject to its General Conditions of Service printed overleaf, available on request or accessible at <http://www.sgs.com/en/Terms-and-Conditions.aspx> and, for electronic format documents, subject to Terms and Conditions for Electronic Documents at <http://www.sgs.com/en/Terms-and-Conditions/Terms-e-Documents.aspx>. Attention is drawn to the limitation of liability, indemnification and jurisdiction issues defined therein. Any holder of this document is advised that information contained hereon reflects the Company's findings at the time of its intervention only and within the limits of Client's instructions, if any. The Company's sole responsibility is to its Client and this document does not exonerate parties to a transaction from exercising all their rights and obligations under the transaction documents. This document cannot be reproduced except in full, without prior written approval of the Company. Any unauthorized alteration, forgery or falsification of the content or appearance of this document is unlawful and offenders may be prosecuted to the fullest extent of the law. Unless otherwise stated the results shown in this test report refer only to the sample(s) tested.

Attention: To check the authenticity of testing / inspection report & certificate, please contact us at telephone: (86-755) 8307 1443, or email: [CN.Doccheck@sgs.com](mailto:CN.Doccheck@sgs.com)

SGS-CSTC Standards Technical Services (Shanghai) Co., Ltd.  
Testing Center - China

3<sup>rd</sup> Building, No.889 Yishan Road Xuhui District, Shanghai China 200233 t E&E (86-21) 61402553 f E&E (86-21) 64953679 www.sgsgroup.com.cn  
中国·上海·徐汇区宜山路889号3号楼 邮编: 200233 t HL (86-21) 61402594 f HL (86-21) 61156899 e [sgs.china@sgs.com](mailto:sgs.china@sgs.com)

# Test Report

No.: SHAEC23000646729\_1

Date: May 06, 2023

Page 2 of 25

Test Requirement	Conclusion
EU RoHS Directive (EU) 2015/863 amending Annex II to Directive 2011/65/EU- Lead, Mercury, Cadmium, Hexavalent chromium, Polybrominated biphenyls (PBBs), Polybrominated diphenyl ethers (PBDEs), Dibutyl phthalate (DBP), Butyl benzyl phthalate (BBP), Bis(2-ethylhexyl) phthalate (DEHP), and Diisobutyl phthalate (DIBP)	Pass
Chlorinated Paraffins	See Results
Dimethyl fumarate (DMFu)	See Results
Element(s)	See Results
Halogen	See Results
Hexabromocyclododecane (HBCDD)	See Results
Phthalates	See Results
Polychlorinated Biphenyls (PCBs)	See Results
Polychlorinated Naphthalenes (PCNs)	See Results
Polychlorinated Terphenyls (PCTs)	See Results
Polyvinyl chloride (PVC)	See Results
Red Phosphorus	See Results
Tetrabromobisphenol A (TBBP-A)	See Results
Bisphenol A	See Results
Perfluorooctanesulfonate (PFOS) and its derivatives and Perfluorooctanoic Acid (PFOA)	See Results
Polycyclic Aromatic Hydrocarbons (PAHs)	See Results

## Test Result(s):

### Test Part Description:

SN ID	Sample No.	SGS Sample ID	Description
SN1	A3	SHA23-0006467-0001.C003	Gray solid pellet

### Remarks:

- (1) 1 mg/kg = 1 ppm = 0.0001%
- (2) MDL = Method Detection Limit
- (3) ND = Not Detected (< MDL)
- (4) “-“ = Not Regulated

**EU RoHS Directive (EU) 2015/863 amending Annex II to Directive 2011/65/EU- Lead, Mercury, Cadmium, Hexavalent chromium, Polybrominated biphenyls (PBBs), Polybrominated diphenyl ethers (PBDEs), Dibutyl phthalate (DBP), Butyl benzyl phthalate (BBP), Bis(2-ethylhexyl) phthalate (DEHP), and Diisobutyl phthalate (DIBP)**



Unless otherwise agreed in writing, this document is issued by the Company subject to its General Conditions of Service printed overleaf, available on request or accessible at <http://www.sgs.com/en/Terms-and-Conditions.aspx> and, for electronic format documents, subject to Terms and Conditions for Electronic Documents at <http://www.sgs.com/en/Terms-and-Conditions/Terms-e-Documents.aspx>. Attention is drawn to the limitation of liability, indemnification and jurisdiction issues defined therein. Any holder of this document is advised that information contained hereon reflects the Company's findings at the time of its intervention only and within the limits of Client's instructions, if any. The Company's sole responsibility is to its Client and this document does not exonerate parties to a transaction from exercising all their rights and obligations under the transaction documents. This document cannot be reproduced except in full, without prior written approval of the Company. Any unauthorized alteration, forgery or falsification of the content or appearance of this document is unlawful and offenders may be prosecuted to the fullest extent of the law. Unless otherwise stated the results shown in this test report refer only to the sample(s) tested.

Attention: To check the authenticity of testing / inspection report & certificate, please contact us at telephone: (86-755) 8307 1443, or email: [CN.Doccheck@sgs.com](mailto:CN.Doccheck@sgs.com)

SGS-CSTC (Shanghai) Technical Services (Shanghai) Co., Ltd.  
Testing Center-Chemistry

3<sup>rd</sup> Building, No. 889 Yishan Road Xuhui District, Shanghai China 200233 t E&E (86-21) 61402553 f E&E (86-21) 64953679 www.sgsgroup.com.cn  
中国·上海·徐汇区宜山路889号3号楼 邮编: 200233 t HL (86-21) 61402594 f HL (86-21) 61156899 e [sgs.china@sgs.com](mailto:sgs.china@sgs.com)

# Test Report

No.: SHAEC23000646729\_1

Date: May 06, 2023

Page 3 of 25

Test Method: With reference to IEC 62321-4:2013+AMD1:2017, IEC 62321-5:2013, IEC 62321-7-2:2017, IEC 62321-6:2015 and IEC62321-8:2017, analysis was performed by ICP-OES, UV-Vis and GC-MS.

Test Item(s)	Limit	Unit(s)	MDL	A3
Cadmium(Cd)	100	mg/kg	2	ND
Lead (Pb)	1000	mg/kg	2	ND
Mercury (Hg)	1000	mg/kg	2	ND
Hexavalent Chromium (Cr(VI))	1000	mg/kg	8	ND
Polybromobiphenyl (PBBs)	1000	mg/kg	-	ND
Monobromobiphenyl (MonoBB)	-	mg/kg	5	ND
Dibromobiphenyl (DiBB)	-	mg/kg	5	ND
Tribromobiphenyl (TriBB)	-	mg/kg	5	ND
Tetrabromobiphenyl (TetraBB)	-	mg/kg	5	ND
Pentabromobiphenyl (PentaBB)	-	mg/kg	5	ND
Hexabromobiphenyl (HexaBB)	-	mg/kg	5	ND
Heptabromobiphenyl (HeptaBB)	-	mg/kg	5	ND
Octabromobiphenyl (OctaBB)	-	mg/kg	5	ND
Nonabromobiphenyl (NonaBB)	-	mg/kg	5	ND
Decabromobiphenyl (DecaBB)	-	mg/kg	5	ND
Polybromodiphenyl ether(PBDEs)	1000	mg/kg	-	ND
Monobromodiphenylether (MonoBDE)	-	mg/kg	5	ND
Dibromodiphenylether (DiBDE)	-	mg/kg	5	ND
Tribromodiphenylether (TriBDE)	-	mg/kg	5	ND
Tetrabromodiphenylether (TetraBDE)	-	mg/kg	5	ND
Pentabromodiphenylether (PentaBDE)	-	mg/kg	5	ND
Hexabromodiphenylether (HexaBDE)	-	mg/kg	5	ND
Heptabromodiphenylether (HeptaBDE)	-	mg/kg	5	ND
Octabromodiphenylether (OctaBDE)	-	mg/kg	5	ND
Nonabromodiphenylether (NonaBDE)	-	mg/kg	5	ND
Decabromodiphenylether (DecaBDE)	-	mg/kg	5	ND
Dibutyl Phthalate(DBP)	1000	mg/kg	50	ND
Benzyl Butyl Phthalate(BBP)	1000	mg/kg	50	ND
Bis-(2-ethylhexyl) Phthalate(DEHP)	1000	mg/kg	50	ND
Diisobutyl Phthalate(DIBP)	1000	mg/kg	50	ND

**Notes:**

- (1) The maximum permissible limit is quoted from RoHS Directive (EU) 2015/863.
- (2) IEC 62321 series is equivalent to EN 62321 series.
- (3) The restriction of DEHP, BBP, DBP and DIBP shall apply to medical devices, including in vitro medical devices, and monitoring and control instruments, including industrial monitoring and control instruments, from 22 July 2021.

**Chlorinated Paraffins**

Test Method: With reference to US EPA 3550C:2007, analysis was performed by GC-ECD / GC-NCI-MS/GC-MS.



Unless otherwise agreed in writing, this document is issued by the Company subject to its General Conditions of Service printed overleaf, available on request or accessible at <http://www.sgs.com/en/Terms-and-Conditions.aspx> and, for electronic format documents, subject to Terms and Conditions for Electronic Documents at <http://www.sgs.com/en/Terms-and-Conditions/Terms-e-Documents.aspx>. Attention is drawn to the limitation of liability, indemnification and jurisdiction issues defined therein. Any holder of this document is advised that information contained hereon reflects the Company's findings at the time of its intervention only and within the limits of Client's instructions, if any. The Company's sole responsibility is to its Client and this document does not exonerate parties to a transaction from exercising all their rights and obligations under the transaction documents. This document cannot be reproduced except in full, without prior written approval of the Company. Any unauthorized alteration, forgery or falsification of the content or appearance of this document is unlawful and offenders may be prosecuted to the fullest extent of the law. Unless otherwise stated the results shown in this test report refer only to the sample(s) tested.

Attention: To check the authenticity of testing / inspection report & certificate, please contact us at telephone: (86-755) 8307 1443, or email: [CN.Doccheck@sgs.com](mailto:CN.Doccheck@sgs.com)

3<sup>rd</sup> Building, No.889 Yishan Road Xuhui District, Shanghai China 200233 t E&E (86-21) 61402553 f E&E (86-21) 64953679 www.sgsgroup.com.cn  
 中国·上海·徐汇区宜山路889号3号楼 邮编: 200233 t HL (86-21) 61402594 f HL (86-21) 61156899 e [sgs.china@sgs.com](mailto:sgs.china@sgs.com)

# Test Report

No.: SHAEC23000646729\_1

Date: May 06, 2023

Page 4 of 25

Test Item(s)	CAS No.	Unit(s)	MDL	A3
Middle Chain Chlorinated Paraffins(MCCP)(C14-C17)	85535-85-9	mg/kg	50	ND
Short Chain Chlorinate Paraffins(SCCP)(C10-C13)	85535-84-8	mg/kg	50	ND

## Dimethyl fumarate (DMFu)

Test Method: With reference to US EPA 3550C:2007, analysis was performed by GC-MS.

Test Item(s)	CAS No.	Unit(s)	MDL	A3
Dimethyl Fumarate (DMFu)	624-49-7	mg/kg	0.1	ND

## Element(s)

Test Method: With reference to US EPA 3052:1996, analysis was performed by ICP-OES.

Test Item(s)	Unit(s)	MDL	A3
Arsenic(As)	mg/kg	10	ND
Antimony(Sb)	mg/kg	10	ND
Beryllium(Be)	mg/kg	5	ND
Phosphorus(P)	mg/kg	20	ND
Antimony Trioxide(Sb <sub>2</sub> O <sub>3</sub> ) ◆	mg/kg	12	ND

### Notes:

◆Sb<sub>2</sub>O<sub>3</sub>: Calculate from Antimony content.

## Halogen

Test Method: With reference to EN 14582:2016, analysis was performed by IC.

Test Item(s)	Unit(s)	MDL	A3
Fluorine(F)	mg/kg	50	ND
Chlorine(Cl)	mg/kg	50	95
Bromine(Br)	mg/kg	50	ND
Iodine(I)	mg/kg	50	ND

## Hexabromocyclododecane (HBCDD)

Test Method: With reference to IEC 62321-9:2021, analysis was performed by GC-MS.

Test Item(s)	CAS No.	Unit(s)	MDL	A3
Hexabromocyclododecane (HBCDD)	134237-50-6	mg/kg	20	ND
	/134237-51-7			
	/134237-52-8			
	/25637-99-4			
	/3194-55-6			

## Phthalates



Unless otherwise agreed in writing, this document is issued by the Company subject to its General Conditions of Service printed overleaf, available on request or accessible at <http://www.sgs.com/en/Terms-and-Conditions.aspx> and, for electronic format documents, subject to Terms and Conditions for Electronic Documents at <http://www.sgs.com/en/Terms-and-Conditions/Terms-e-Documents.aspx>. Attention is drawn to the limitation of liability, indemnification and jurisdiction issues defined therein. Any holder of this document is advised that information contained hereon reflects the Company's findings at the time of its intervention only and within the limits of Client's instructions, if any. The Company's sole responsibility is to its Client and this document does not exonerate parties to a transaction from exercising all their rights and obligations under the transaction documents. This document cannot be reproduced except in full, without prior written approval of the Company. Any unauthorized alteration, forgery or falsification of the content or appearance of this document is unlawful and offenders may be prosecuted to the fullest extent of the law. Unless otherwise stated the results shown in this test report refer only to the sample(s) tested.

Attention: To check the authenticity of testing / inspection report & certificate, please contact us at telephone: (86-755) 8307 1443, or email: [CN.Doccheck@sgs.com](mailto:CN.Doccheck@sgs.com)

3<sup>rd</sup> Building, No. 889 Yishan Road Xuhui District, Shanghai China 200233 t E&E (86-21) 61402553 f E&E (86-21) 64953679 www.sgsgroup.com.cn  
 中国·上海·徐汇区宜山路889号3号楼 邮编: 200233 t HL (86-21) 61402594 f HL (86-21) 61156899 e [sgs.china@sgs.com](mailto:sgs.china@sgs.com)



# Test Report

No.: SHAEC23000646729\_1

Date: May 06, 2023

Page 5 of 25

Test Method: With reference to IEC 62321-8:2017, analysis was performed by GC-MS.

Test Item(s)	Unit(s)	MDL	A3
Diisononyl Phthalate (DINP)	mg/kg	50	ND
Di-n-Octyl Phthalate(DNOP)	mg/kg	50	ND
Diisodecyl Phthalate (DIDP)	mg/kg	50	ND
Di-n-Hexyl Phthalate(DnHP)	mg/kg	50	ND
Dipentyl Phthalate	mg/kg	50	ND
Diphenyl Phthalate(DPhP)	mg/kg	50	ND
Dimethyl Phthalate(DMP)	mg/kg	50	ND
Diethyl Phthalate(DEP)	mg/kg	50	ND
Dipropyl Phthalate(DPrP)	mg/kg	50	ND
Dicyclohexyl Phthalate(DCHP)	mg/kg	50	ND
Dibenzyl Phthalate(DBzP)	mg/kg	50	ND
Dinonyl Phthalate(DNP)	mg/kg	50	ND
Diisooctyl Phthalate(DIOP)	mg/kg	50	ND

## Polychlorinated Biphenyls (PCBs)

Test Method: With reference to US EPA 8082A:2007, analysis was performed by GC-MS.

Test Item(s)	CAS No.	Unit(s)	MDL	A3
2,4,4'-Trichlorobiphenyl (PCB28)	7012-37-5	mg/kg	0.5	ND
2,2',5,5'-Tetrachlorobiphenyl (PCB52)	35693-99-3	mg/kg	0.5	ND
2,2',4,5,5'-Pentachlorobiphenyl (PCB101)	37680-73-2	mg/kg	0.5	ND
2,3',4,4',5-Pentachlorobiphenyl (PCB118)	31508-00-6	mg/kg	0.5	ND
2,2',3,4,4',5'-Hexachlorobiphenyl (PCB138)	35065-28-2	mg/kg	0.5	ND
2,2',4,4',5,5'-Hexachlorobiphenyl (PCB153)	35065-27-1	mg/kg	0.5	ND
2,2',3,4,4',5,5'-Heptachlorobiphenyl (PCB180)	35065-29-3	mg/kg	0.5	ND
Sum of PCBs	-	mg/kg	-	ND

## Polychlorinated Naphthalenes (PCNs)

Test Method: With reference to US EPA 8081B:2007, analysis was performed by GC-MS.

Test Item(s)	CAS No.	Unit(s)	MDL	A3
1-Chlorinated Naphthalene	90-13-1	mg/kg	5	ND
2-Chlorinated Naphthalene	91-58-7	mg/kg	5	ND
1,4- Dichlorinated Naphthalene	1825-31-6	mg/kg	5	ND
1,5-Dichlorinated Naphthalene	1825-30-5	mg/kg	5	ND
1,2-Dichlorinated Naphthalene	2050-69-3	mg/kg	5	ND
1,8-Dichlorinated Naphthalene	2050-74-0	mg/kg	5	ND
1,2,3-Trichlorinated Naphthalene	50402-52-3	mg/kg	5	ND
1,2,3,4-Tetrachlorinated Naphthalene	20020-02-4	mg/kg	5	ND
1,2,3,4,6-Pentachlorinated Naphthalene	67922-26-3	mg/kg	5	ND



Unless otherwise agreed in writing, this document is issued by the Company subject to its General Conditions of Service printed overleaf, available on request or accessible at <http://www.sgs.com/en/Terms-and-Conditions.aspx> and, for electronic format documents, subject to Terms and Conditions for Electronic Documents at <http://www.sgs.com/en/Terms-and-Conditions/Terms-e-Documents.aspx>. Attention is drawn to the limitation of liability, indemnification and jurisdiction issues defined therein. Any holder of this document is advised that information contained hereon reflects the Company's findings at the time of its intervention only and within the limits of Client's instructions, if any. The Company's sole responsibility is to its Client and this document does not exonerate parties to a transaction from exercising all their rights and obligations under the transaction documents. This document cannot be reproduced except in full, without prior written approval of the Company. Any unauthorized alteration, forgery or falsification of the content or appearance of this document is unlawful and offenders may be prosecuted to the fullest extent of the law. Unless otherwise stated the results shown in this test report refer only to the sample(s) tested.

Attention: To check the authenticity of testing /inspection report & certificate, please contact us at telephone: (86-755) 8307 1443, or email: [CN.Doccheck@sgs.com](mailto:CN.Doccheck@sgs.com)

SGS-CSTC (Shanghai) Technical Services (Shanghai) Co., Ltd.  
Testing Center-Chemical Laboratory

3<sup>rd</sup> Building, No.889 Yishan Road Xuhui District, Shanghai China 200233  
中国·上海·徐汇区宜山路889号3号楼 邮编: 200233

t E&E (86-21) 61402553 f E&E (86-21) 64953679 www.sgsgroup.com.cn  
t HL (86-21) 61402594 f HL (86-21) 61156899 e [sgs.china@sgs.com](mailto:sgs.china@sgs.com)

# Test Report

No.: SHAEC23000646729\_1

Date: May 06, 2023

Page 6 of 25

Test Item(s)	CAS No.	Unit(s)	MDL	A3
Octa-chlorinated Naphthalene	2234-13-1	mg/kg	5	ND

## Polychlorinated Terphenyls (PCTs)

Test Method: With reference to US EPA 8082A: 2007, analysis was performed by GC-MS.

Test Item(s)	CAS No.	Unit(s)	MDL	A3
Aroclor 5432	63496-31-1	mg/kg	0.5	ND
Aroclor 5442	12642-23-8	mg/kg	0.5	ND
Aroclor 5460	11126-42-4	mg/kg	0.5	ND

## Polyvinyl chloride (PVC)

Test Method: With reference to SGS in house method, analysis was performed by FTIR/HATR.

Test Item(s)	A3
Polyvinyl chloride (PVC)	Negative

### Notes:

(1) Negative=The sample does not contain Polyvinylchloride (PVC),Positive=The sample contains Polyvinylchloride (PVC)

## Red Phosphorus

Test Method: With reference to SGS In house method, analysis was performed by ICP-OES and Pyrolysis-GC-MS.

Test Item(s)	CAS No.	Unit(s)	MDL	A3
Red Phosphorus	7723-14-0	mg/kg	500	ND

### Notes:

(1) The testing result is based on the worst-case scenario, and confirmed by Pyrolysis-GC-MS.

## Tetrabromobisphenol A (TBBP-A)

Test Method: With reference to IEC 62321:2008, analysis was performed by GC-MS.

Test Item(s)	CAS No.	Unit(s)	MDL	A3
Tetrabromobisphenol A(TBBPA)	79-94-7	mg/kg	10	ND

## Bisphenol A

Test Method: With reference to US EPA 3550C:2007, analysis was performed by LC-MS.

Test Item(s)	CAS No.	Unit(s)	MDL	A3
Bisphenol A(BPA)	80-05-7	mg/kg	1	ND

## Perfluorooctanesulfonate (PFOS) and its derivatives and Perfluorooctanoic Acid (PFOA)



Unless otherwise agreed in writing, this document is issued by the Company subject to its General Conditions of Service printed overleaf, available on request or accessible at <http://www.sgs.com/en/Terms-and-Conditions.aspx> and, for electronic format documents, subject to Terms and Conditions for Electronic Documents at <http://www.sgs.com/en/Terms-and-Conditions/Terms-e-Documents.aspx>. Attention is drawn to the limitation of liability, indemnification and jurisdiction issues defined therein. Any holder of this document is advised that information contained hereon reflects the Company's findings at the time of its intervention only and within the limits of Client's instructions, if any. The Company's sole responsibility is to its Client and this document does not exonerate parties to a transaction from exercising all their rights and obligations under the transaction documents. This document cannot be reproduced except in full, without prior written approval of the Company. Any unauthorized alteration, forgery or falsification of the content or appearance of this document is unlawful and offenders may be prosecuted to the fullest extent of the law. Unless otherwise stated the results shown in this test report refer only to the sample(s) tested.

Attention: To check the authenticity of testing /inspection report & certificate, please contact us at telephone: (86-755) 8307 1443, or email: [CN.Doccheck@sgs.com](mailto:CN.Doccheck@sgs.com)

SGS-CSTC (Shanghai) Technical Services (Shanghai) Co., Ltd.  
Testing Center-Chemical Laboratory

3<sup>rd</sup> Building, No.889 Yishan Road Xuhui District, Shanghai China 200233 t E&E (86-21) 61402553 f E&E (86-21) 64953679 www.sgsgroup.com.cn  
中国·上海·徐汇区宜山路889号3号楼 邮编: 200233 t HL (86-21) 61402594 f HL (86-21) 61156899 e [sgs.china@sgs.com](mailto:sgs.china@sgs.com)

# Test Report

No.: SHAEC23000646729\_1

Date: May 06, 2023

Page 7 of 25

Test Method: With reference to CEN/TS 15968:2010, analysis was performed by HPLC-MS or LC-MS/MS.

Test Item(s)	CAS No.	Unit(s)	MDL	A3
Perfluorooctanesulfonic acid (PFOS)^	1763-23-1	mg/kg	0.01	ND
Perfluorooctanoic Acid (PFOA) and its salts+	335-67-1	mg/kg	0.01	ND

**Notes:**

- (1) + PFOA refer to its salts including PFOA-Na (CAS No.: 335-95-5), PFOA-K (CAS No.: 2395-00-8), PFOA-Ag (CAS No.: 335-93-3), PFOA-F (CAS No.: 335-66-0) and APFO (CAS No.: 3825-26-1);
- (2) ^ PFOS including PFOS-K (CAS No.: 2795-39-3), PFOS-Li (CAS No.: 29457-72-5), PFOS-NH<sub>4</sub> (CAS No.: 29081-56-9), PFOS-NH(OH)<sub>2</sub> (CAS No.: 70225-14-8), PFOS-N(C<sub>2</sub>H<sub>5</sub>)<sub>4</sub> (CAS No.: 56773-42-3), PFOS-DDA (CAS No.: 251099-16-8) and POSF (CAS No.: 307-35-7).

**Polycyclic Aromatic Hydrocarbons (PAHs)**

Test Method: With reference to AfPS GS 2014:01 PAK, analysis was performed by GC-MS.

Test Item(s)	CAS No.	Unit(s)	MDL	A3
Benzo(a)pyrene(BaP)	50-32-8	mg/kg	0.1	ND
Benzo(e)pyrene(BeP)	192-97-2	mg/kg	0.1	ND
Benzo(a)anthracene(BaA)	56-55-3	mg/kg	0.1	ND
Benzo(b)Fluoranthene(BbF)	205-99-2	mg/kg	0.1	ND
Benzo(j)fluoranthene(BjF)	205-82-3	mg/kg	0.1	ND
Benzo(k)Fluoranthene(BkF)	207-08-9	mg/kg	0.1	ND
Chrysene(CHR)	218-01-9	mg/kg	0.1	ND
Dibenzo(a,h)Anthracene(DBA)	53-70-3	mg/kg	0.1	ND
Benzo(g,h,i)perylene(BPE)	191-24-2	mg/kg	0.1	ND
Indeno(1,2,3-c,d)pyrene(IPY)	193-39-5	mg/kg	0.1	ND
Acenaphthylene(ANY)	208-96-8	mg/kg	0.1	ND
Acenaphthene(ANA)	83-32-9	mg/kg	0.1	ND
Fluorene(FLU)	86-73-7	mg/kg	0.1	ND
Phenanthrene(PHE)	85-01-8	mg/kg	0.1	ND
Pyrene(PYR)	129-00-0	mg/kg	0.1	ND
Anthracene(ANT)	120-12-7	mg/kg	0.1	ND
Fluoranthene(FLT)	206-44-0	mg/kg	0.1	ND
Sum of Acenaphthylene, Acenaphthene, Fluorene, Phenanthrene, Pyrene, Anthracene, Fluoranthene	-	mg/kg	-	ND
Naphthalene(NAP)	91-20-3	mg/kg	0.1	ND
Sum of 18 PAHs	-	mg/kg	-	ND
Material Category	-	mg/kg	-	-

**Notes:**

**AfPS (German commission for Product Safety) : GS PAHs requirements**

Parameter	Category 1	Category 2	Category 3
-----------	------------	------------	------------



Unless otherwise agreed in writing, this document is issued by the Company subject to its General Conditions of Service printed overleaf, available on request or accessible at <http://www.sgs.com/en/Terms-and-Conditions.aspx> and, for electronic format documents, subject to Terms and Conditions for Electronic Documents at <http://www.sgs.com/en/Terms-and-Conditions/Terms-e-Documents.aspx>. Attention is drawn to the limitation of liability, indemnification and jurisdiction issues defined therein. Any holder of this document is advised that information contained hereon reflects the Company's findings at the time of its intervention only and within the limits of Client's instructions, if any. The Company's sole responsibility is to its Client and this document does not exonerate parties to a transaction from exercising all their rights and obligations under the transaction documents. This document cannot be reproduced except in full, without prior written approval of the Company. Any unauthorized alteration, forgery or falsification of the content or appearance of this document is unlawful and offenders may be prosecuted to the fullest extent of the law. Unless otherwise stated the results shown in this test report refer only to the sample(s) tested.

Attention: To check the authenticity of testing / inspection report & certificate, please contact us at telephone: (86-755) 8307 1443, or email: [CN.Doccheck@sgs.com](mailto:CN.Doccheck@sgs.com)

3<sup>rd</sup> Building, No.889 Yishan Road Xuhui District, Shanghai China 200233 t E&E (86-21) 61402553 f E&E (86-21) 64953679 www.sgs.com.cn  
 中国·上海·徐汇区宜山路889号3号楼 邮编: 200233 t HL (86-21) 61402594 f HL (86-21) 61156899 e [sgs.china@sgs.com](mailto:sgs.china@sgs.com)

	Material intended to be put in the mouth or toys with intended skin contact (longer than 30 s).	Materials not falling under category 1 with foreseeable contact to skin for longer than 30 s (long-term skin) or frequent contact.		Materials not falling under category 1 or 2 with foreseeable contact to skin for less than 30 s (short-term skin contact).	
		Toy under 2009/48/EC	Other products under ProdSG	Toy under 2009/48/EC	Other products under ProdSG
Benzo(a)pyrene mg/kg	< 0.2	< 0.2	< 0.5	< 0.5	< 1
Benzo(e)pyrene mg/kg	< 0.2	< 0.2	< 0.5	< 0.5	< 1
Benzo(a)anthracene mg/kg	< 0.2	< 0.2	< 0.5	< 0.5	< 1
Benzo(b)fluoranthene mg/kg	< 0.2	< 0.2	< 0.5	< 0.5	< 1
Benzo(j)fluoranthene mg/kg	< 0.2	< 0.2	< 0.5	< 0.5	< 1
Benzo(k)fluoranthene mg/kg	< 0.2	< 0.2	< 0.5	< 0.5	< 1
Chrysene mg/kg	< 0.2	< 0.2	< 0.5	< 0.5	< 1
Dibenzo(a,h)anthracene mg/kg	< 0.2	< 0.2	< 0.5	< 0.5	< 1
Benzo(g,h,i)perylene mg/kg	< 0.2	< 0.2	< 0.5	< 0.5	< 1
Indeno(1,2,3-cd)pyrene mg/kg	< 0.2	< 0.2	< 0.5	< 0.5	< 1
Acenaphthylene, Acenaphthene, fluorene, phenanthrene, pyrene, anthracene, fluoranthene, mg/kg	< 1 Sum	< 5 Sum	< 10 Sum	< 20 Sum	< 50 Sum
Naphthalene, mg/kg	< 1	< 2		< 10	
Sum of 18 PAHs	< 1	< 5	< 10	< 20	< 50

This report updates Client Ref. Information.

Unless otherwise stated, the decision rule for conformity reporting is based on Binary Statement for Simple Acceptance Rule ( $w=0$ ) stated in ILAC-G8:09/2019.



Unless otherwise agreed in writing, this document is issued by the Company subject to its General Conditions of Service printed overleaf, available on request or accessible at <http://www.sgs.com/en/Terms-and-Conditions.aspx> and, for electronic format documents, subject to Terms and Conditions for Electronic Documents at <http://www.sgs.com/en/Terms-and-Conditions/Terms-e-Documents.aspx>. Attention is drawn to the limitation of liability, indemnification and jurisdiction issues defined therein. Any holder of this document is advised that information contained hereon reflects the Company's findings at the time of its intervention only and within the limits of Client's instructions, if any. The Company's sole responsibility is to its Client and this document does not exonerate parties to a transaction from exercising all their rights and obligations under the transaction documents. This document cannot be reproduced except in full, without prior written approval of the Company. Any unauthorized alteration, forgery or falsification of the content or appearance of this document is unlawful and offenders may be prosecuted to the fullest extent of the law. Unless otherwise stated the results shown in this test report refer only to the sample(s) tested.

Attention: To check the authenticity of testing / inspection report & certificate, please contact us at telephone: (86-755) 8307 1443, or email: [CN.Doccheck@sgs.com](mailto:CN.Doccheck@sgs.com)

3<sup>rd</sup> Building, No.889 Yishan Road Xuhui District, Shanghai China 200233 t E&E (86-21) 61402553 f E&E (86-21) 64953679 www.sgsgroup.com.cn  
 中国·上海·徐汇区宜山路889号3号楼 邮编: 200233 t HL (86-21) 61402594 f HL (86-21) 61156899 e [sgs.china@sgs.com](mailto:sgs.china@sgs.com)



**Elements Testing Flow Chart**

These samples were dissolved totally by pre-conditioning method according to below flow chart.

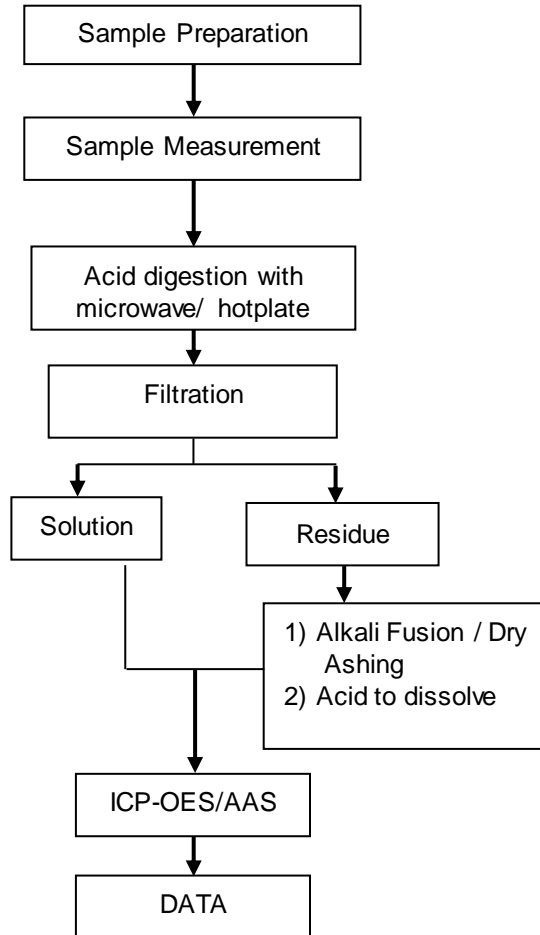

ATTACHMENTS

Hexavalent Chromium (Cr(VI)) Testing Flow Chart

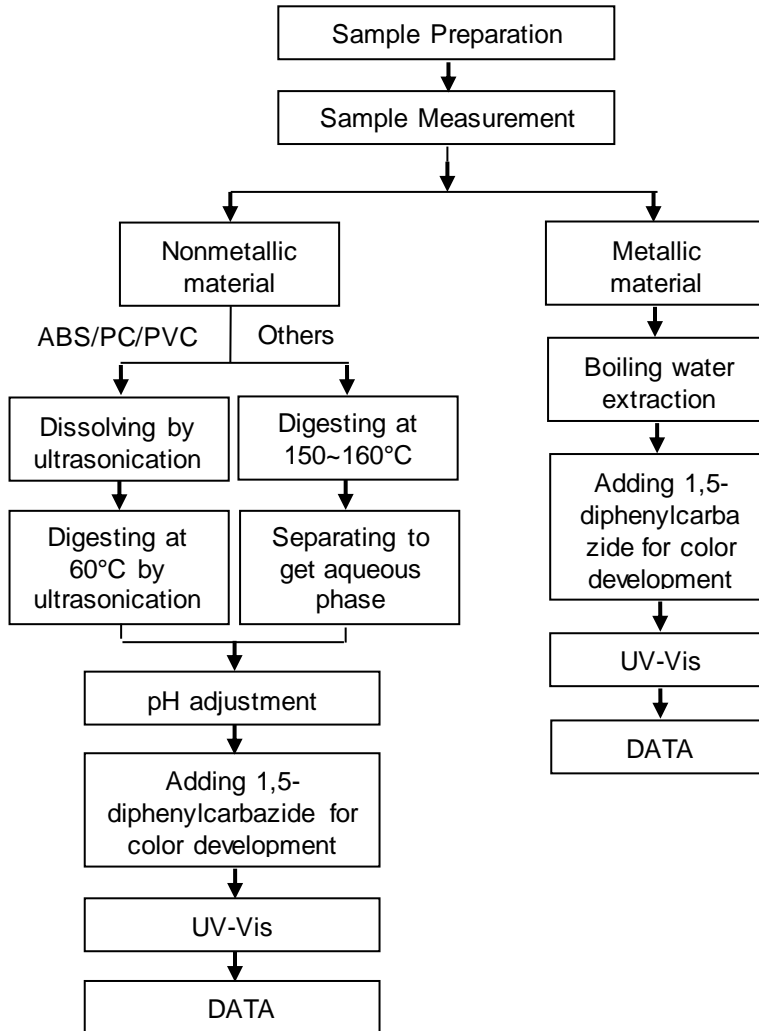

Unless otherwise agreed in writing, this document is issued by the Company subject to its General Conditions of Service printed overleaf, available on request or accessible at <http://www.sgs.com/en/Terms-and-Conditions.aspx> and, for electronic format documents, subject to Terms and Conditions for Electronic Documents at <http://www.sgs.com/en/Terms-and-Conditions/Terms-e-Documents.aspx>. Attention is drawn to the limitation of liability, indemnification and jurisdiction issues defined therein. Any holder of this document is advised that information contained hereon reflects the Company's findings at the time of its intervention only and within the limits of Client's instructions, if any. The Company's sole responsibility is to its Client and this document does not exonerate parties to a transaction from exercising all their rights and obligations under the transaction documents. This document cannot be reproduced except in full, without prior written approval of the Company. Any unauthorized alteration, forgery or falsification of the content or appearance of this document is unlawful and offenders may be prosecuted to the fullest extent of the law. Unless otherwise stated the results shown in this test report refer only to the sample(s) tested.

Attention: To check the authenticity of testing / inspection report & certificate, please contact us at telephone: (86-755) 8307 1443, or email: [CN.Doccheck@sgs.com](mailto:CN.Doccheck@sgs.com)

SGS-CSTC (Shanghai) Technical Services Co., Ltd. 3rd Building, No.889 Yishan Road Xuhui District, Shanghai China 200233 t E&E (86-21) 61402553 f E&E (86-21) 64953679 www.sgsgroup.com.cn  
 中国·上海·徐汇区宜山路889号3号楼 邮编: 200233 t HL (86-21) 61402594 f HL (86-21) 61156899 e sgs.china@sgs.com

### PBBs/PBDEs Testing Flow Chart

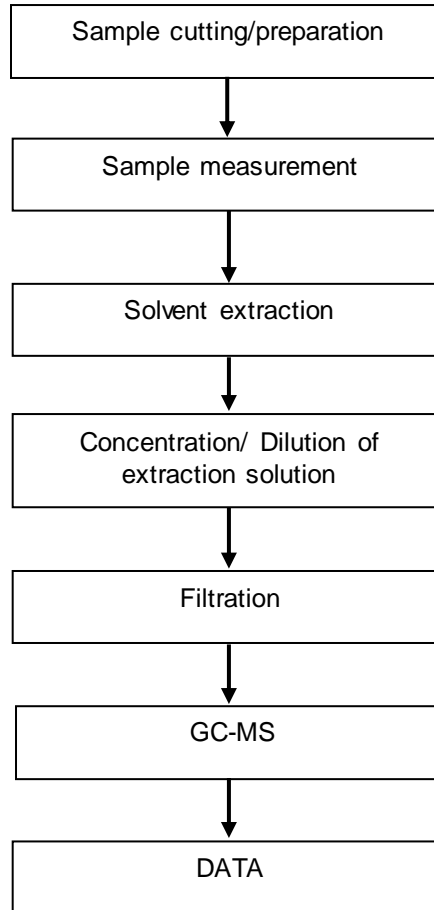

### Phthalates Testing Flow Chart

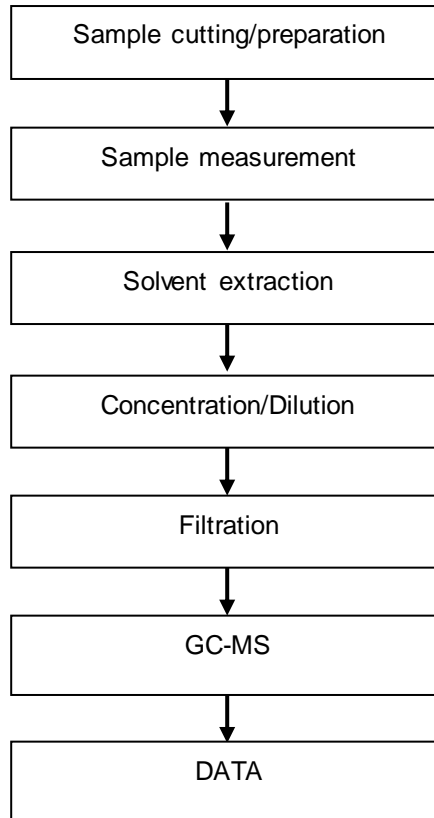

SGS-CSSTC (Shanghai) Inspection & Testing Services Co., Ltd.  
Testing Center-Chemical Laboratory

Unless otherwise agreed in writing, this document is issued by the Company subject to its General Conditions of Service printed overleaf, available on request or accessible at <http://www.sgs.com/en/Terms-and-Conditions.aspx> and, for electronic format documents, subject to Terms and Conditions for Electronic Documents at <http://www.sgs.com/en/Terms-and-Conditions/Terms-e-Documents.aspx>. Attention is drawn to the limitation of liability, indemnification and jurisdiction issues defined therein. Any holder of this document is advised that information contained hereon reflects the Company's findings at the time of its intervention only and within the limits of Client's instructions, if any. The Company's sole responsibility is to its Client and this document does not exonerate parties to a transaction from exercising all their rights and obligations under the transaction documents. This document cannot be reproduced except in full, without prior written approval of the Company. Any unauthorized alteration, forgery or falsification of the content or appearance of this document is unlawful and offenders may be prosecuted to the fullest extent of the law. Unless otherwise stated the results shown in this test report refer only to the sample(s) tested.

Attention: To check the authenticity of testing / inspection report & certificate, please contact us at telephone: (86-755) 8307 1443, or email: [CN.Doccheck@sgs.com](mailto:CN.Doccheck@sgs.com)

3<sup>rd</sup> Building, No.889 Yishan Road Xuhui District, Shanghai China 200233 t E&E (86-21) 61402553 f E&E (86-21) 64953679 www.sgsgroup.com.cn  
中国·上海·徐汇区宜山路889号3号楼 邮编: 200233 t HL (86-21) 61402594 f HL (86-21) 61156899 e [sgs.china@sgs.com](mailto:sgs.china@sgs.com)



## Chlorinated Paraffin Testing Flow Chart

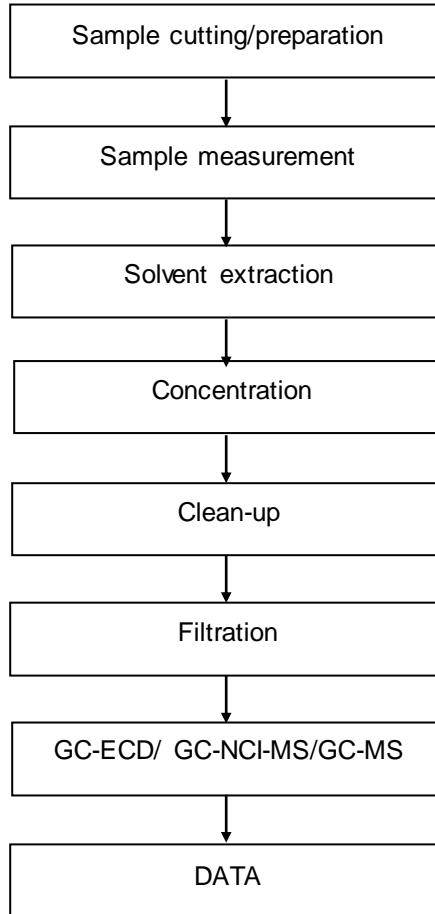

SGS-CSSTC (Shanghai) Co., Ltd.  
Testing Center-Chemical Laboratory

Unless otherwise agreed in writing, this document is issued by the Company subject to its General Conditions of Service printed overleaf, available on request or accessible at <http://www.sgs.com/en/Terms-and-Conditions.aspx> and, for electronic format documents, subject to Terms and Conditions for Electronic Documents at <http://www.sgs.com/en/Terms-and-Conditions/Terms-e-Documents.aspx>. Attention is drawn to the limitation of liability, indemnification and jurisdiction issues defined therein. Any holder of this document is advised that information contained hereon reflects the Company's findings at the time of its intervention only and within the limits of Client's instructions, if any. The Company's sole responsibility is to its Client and this document does not exonerate parties to a transaction from exercising all their rights and obligations under the transaction documents. This document cannot be reproduced except in full, without prior written approval of the Company. Any unauthorized alteration, forgery or falsification of the content or appearance of this document is unlawful and offenders may be prosecuted to the fullest extent of the law. Unless otherwise stated the results shown in this test report refer only to the sample(s) tested.

Attention: To check the authenticity of testing /inspection report & certificate, please contact us at telephone: (86-755) 8307 1443, or email: [CN.Doccheck@sgs.com](mailto:CN.Doccheck@sgs.com)

3<sup>rd</sup> Building, No.889 Yishan Road Xuhui District, Shanghai China 200233 t E&E (86-21) 61402553 f E&E (86-21) 64953679 www.sgsgroup.com.cn  
中国·上海·徐汇区宜山路889号3号楼 邮编: 200233 t HL (86-21) 61402594 f HL (86-21) 61156899 e sgs.china@sgs.com

## DMF (Dimethyl fumarate) Testing Flow Chart

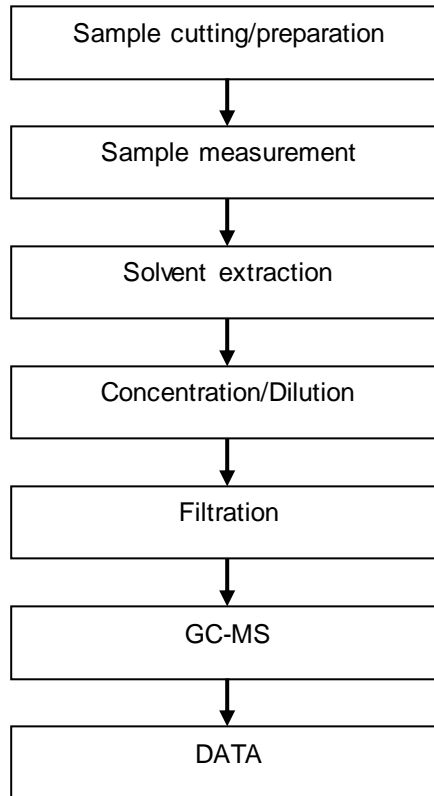

### Elements Testing Flow Chart

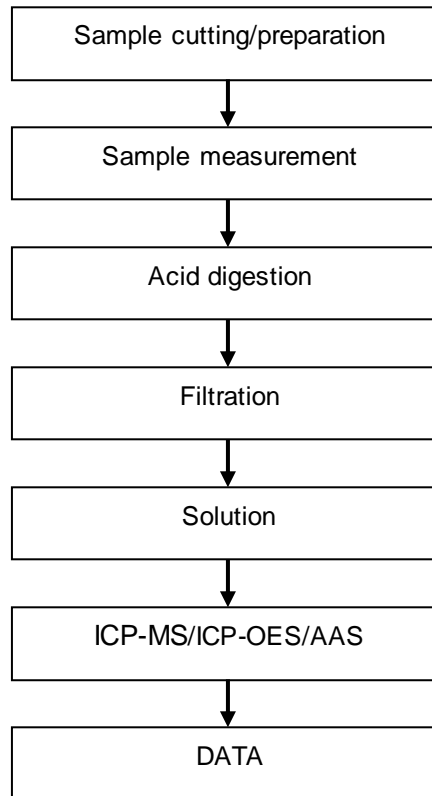

Unless otherwise agreed in writing, this document is issued by the Company subject to its General Conditions of Service printed overleaf, available on request or accessible at <http://www.sgs.com/en/Terms-and-Conditions.aspx> and, for electronic format documents, subject to Terms and Conditions for Electronic Documents at <http://www.sgs.com/en/Terms-and-Conditions/Terms-e-Documents.aspx>. Attention is drawn to the limitation of liability, indemnification and jurisdiction issues defined therein. Any holder of this document is advised that information contained hereon reflects the Company's findings at the time of its intervention only and within the limits of Client's instructions, if any. The Company's sole responsibility is to its Client and this document does not exonerate parties to a transaction from exercising all their rights and obligations under the transaction documents. This document cannot be reproduced except in full, without prior written approval of the Company. Any unauthorized alteration, forgery or falsification of the content or appearance of this document is unlawful and offenders may be prosecuted to the fullest extent of the law. Unless otherwise stated the results shown in this test report refer only to the sample(s) tested.

Attention: To check the authenticity of testing /inspection report & certificate, please contact us at telephone: (86-755) 8307 1443, or email: [CN.Doccheck@sgs.com](mailto:CN.Doccheck@sgs.com)

SGS-CSTC Standards Technical Services (Shanghai) Co., Ltd. 3<sup>rd</sup> Building, No.889 Yishan Road Xuhui District, Shanghai China 200233 t E&E (86-21) 61402553 f E&E (86-21) 64953679 www.sgsgroup.com.cn  
中国·上海·徐汇区宜山路889号3号楼 邮编: 200233 t HL (86-21) 61402594 f HL (86-21) 61156899 e sgs.china@sgs.com

### Halogen Testing Flow Chart

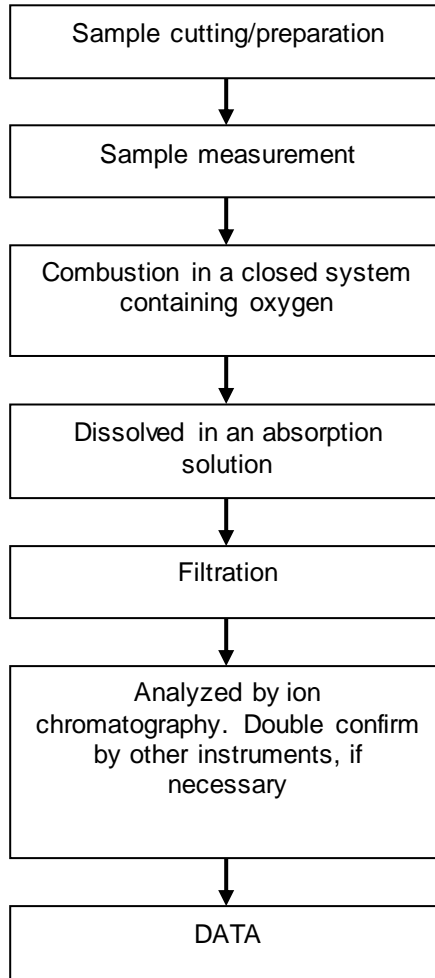

SGS-CSTC Standards Technical Services (Shanghai) Co., Ltd.  
Testing Center-Chemical Laboratory

Unless otherwise agreed in writing, this document is issued by the Company subject to its General Conditions of Service printed overleaf, available on request or accessible at <http://www.sgs.com/en/Terms-and-Conditions.aspx> and, for electronic format documents, subject to Terms and Conditions for Electronic Documents at <http://www.sgs.com/en/Terms-and-Conditions/Terms-e-Documents.aspx>. Attention is drawn to the limitation of liability, indemnification and jurisdiction issues defined therein. Any holder of this document is advised that information contained hereon reflects the Company's findings at the time of its intervention only and within the limits of Client's instructions, if any. The Company's sole responsibility is to its Client and this document does not exonerate parties to a transaction from exercising all their rights and obligations under the transaction documents. This document cannot be reproduced except in full, without prior written approval of the Company. Any unauthorized alteration, forgery or falsification of the content or appearance of this document is unlawful and offenders may be prosecuted to the fullest extent of the law. Unless otherwise stated the results shown in this test report refer only to the sample(s) tested.

Attention: To check the authenticity of testing / inspection report & certificate, please contact us at telephone: (86-755) 8307 1443, or email: [CN.Doccheck@sgs.com](mailto:CN.Doccheck@sgs.com)

3<sup>rd</sup> Building, No. 889 Yishan Road Xuhui District, Shanghai China 200233 t E&E (86-21) 61402553 f E&E (86-21) 64953679 www.sgsgroup.com.cn  
中国·上海·徐汇区宜山路889号3号楼 邮编: 200233 t HL (86-21) 61402594 f HL (86-21) 61156899 e [sgs.china@sgs.com](mailto:sgs.china@sgs.com)



### HBCDD Testing Flow Chart

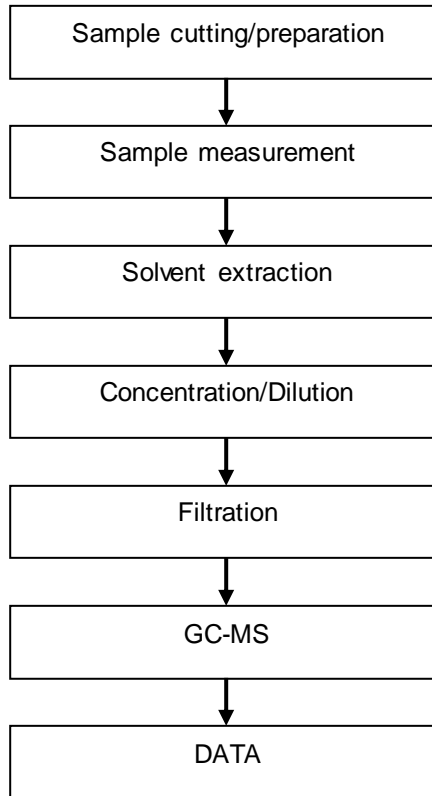

SGS-CSTC Standards Technical Services (Shanghai) Co., Ltd.  
Testing Center-Chemical Laboratory

Unless otherwise agreed in writing, this document is issued by the Company subject to its General Conditions of Service printed overleaf, available on request or accessible at <http://www.sgs.com/en/Terms-and-Conditions.aspx> and, for electronic format documents, subject to Terms and Conditions for Electronic Documents at <http://www.sgs.com/en/Terms-and-Conditions/Terms-e-Documents.aspx>. Attention is drawn to the limitation of liability, indemnification and jurisdiction issues defined therein. Any holder of this document is advised that information contained hereon reflects the Company's findings at the time of its intervention only and within the limits of Client's instructions, if any. The Company's sole responsibility is to its Client and this document does not exonerate parties to a transaction from exercising all their rights and obligations under the transaction documents. This document cannot be reproduced except in full, without prior written approval of the Company. Any unauthorized alteration, forgery or falsification of the content or appearance of this document is unlawful and offenders may be prosecuted to the fullest extent of the law. Unless otherwise stated the results shown in this test report refer only to the sample(s) tested.

Attention: To check the authenticity of testing / inspection report & certificate, please contact us at telephone: (86-755) 8307 1443, or email: [CN.Doccheck@sgs.com](mailto:CN.Doccheck@sgs.com)

3<sup>rd</sup> Building, No.889 Yishan Road Xuhui District, Shanghai China 200233 t E&E (86-21) 61402553 f E&E (86-21) 64953679 www.sgsgroup.com.cn  
中国·上海·徐汇区宜山路889号3号楼 邮编: 200233 t HL (86-21) 61402594 f HL (86-21) 61156899 e sgs.china@sgs.com

### PCB Testing Flow Chart

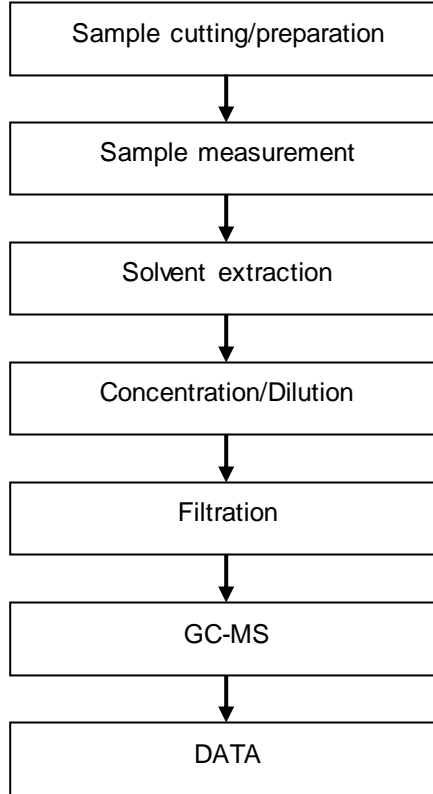

SGS-CSTC Standards Technical Services (Shanghai) Co., Ltd.  
Testing Center-Chemical Laboratory

Unless otherwise agreed in writing, this document is issued by the Company subject to its General Conditions of Service printed overleaf, available on request or accessible at <http://www.sgs.com/en/Terms-and-Conditions.aspx> and, for electronic format documents, subject to Terms and Conditions for Electronic Documents at <http://www.sgs.com/en/Terms-and-Conditions/Terms-e-Documents.aspx>. Attention is drawn to the limitation of liability, indemnification and jurisdiction issues defined therein. Any holder of this document is advised that information contained hereon reflects the Company's findings at the time of its intervention only and within the limits of Client's instructions, if any. The Company's sole responsibility is to its Client and this document does not exonerate parties to a transaction from exercising all their rights and obligations under the transaction documents. This document cannot be reproduced except in full, without prior written approval of the Company. Any unauthorized alteration, forgery or falsification of the content or appearance of this document is unlawful and offenders may be prosecuted to the fullest extent of the law. Unless otherwise stated the results shown in this test report refer only to the sample(s) tested.

Attention: To check the authenticity of testing / inspection report & certificate, please contact us at telephone: (86-755) 8307 1443, or email: [CN.Doccheck@sgs.com](mailto:CN.Doccheck@sgs.com)

3<sup>rd</sup> Building, No. 889 Yishan Road Xuhui District, Shanghai China 200233 t E&E (86-21) 61402553 f E&E (86-21) 64953679 www.sgsgroup.com.cn  
中国·上海·徐汇区宜山路889号3号楼 邮编: 200233 t HL (86-21) 61402594 f HL (86-21) 61156899 e sgs.china@sgs.com

### PCN Testing Flow Chart

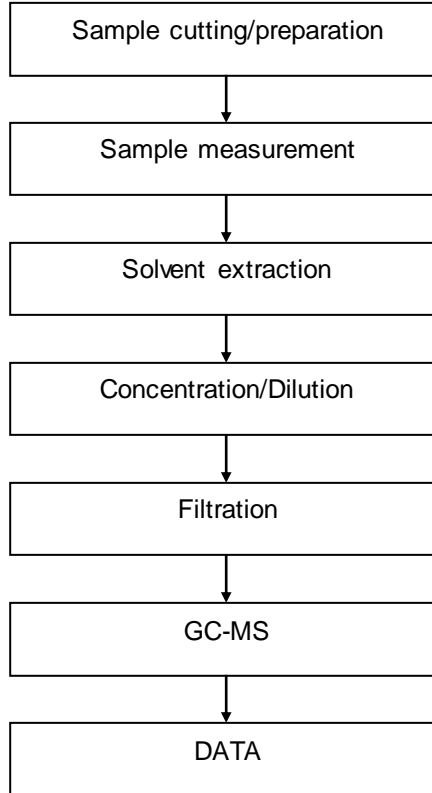

SGS CSTC (Shanghai) Inspection & Testing Services Co., Ltd.  
Testing Center-Chemical Laboratory

Unless otherwise agreed in writing, this document is issued by the Company subject to its General Conditions of Service printed overleaf, available on request or accessible at <http://www.sgs.com/en/Terms-and-Conditions.aspx> and, for electronic format documents, subject to Terms and Conditions for Electronic Documents at <http://www.sgs.com/en/Terms-and-Conditions/Terms-e-Documents.aspx>. Attention is drawn to the limitation of liability, indemnification and jurisdiction issues defined therein. Any holder of this document is advised that information contained hereon reflects the Company's findings at the time of its intervention only and within the limits of Client's instructions, if any. The Company's sole responsibility is to its Client and this document does not exonerate parties to a transaction from exercising all their rights and obligations under the transaction documents. This document cannot be reproduced except in full, without prior written approval of the Company. Any unauthorized alteration, forgery or falsification of the content or appearance of this document is unlawful and offenders may be prosecuted to the fullest extent of the law. Unless otherwise stated the results shown in this test report refer only to the sample(s) tested.

Attention: To check the authenticity of testing / inspection report & certificate, please contact us at telephone: (86-755) 8307 1443, or email: [CN.Doccheck@sgs.com](mailto:CN.Doccheck@sgs.com)

3<sup>rd</sup> Building, No.889 Yishan Road Xuhui District, Shanghai China 200233 t E&E (86-21) 61402553 f E&E (86-21) 64953679 www.sgsgroup.com.cn  
中国·上海·徐汇区宜山路889号3号楼 邮编: 200233 t HL (86-21) 61402594 f HL (86-21) 61156899 e [sgs.china@sgs.com](mailto:sgs.china@sgs.com)

### PCT Testing Flow Chart

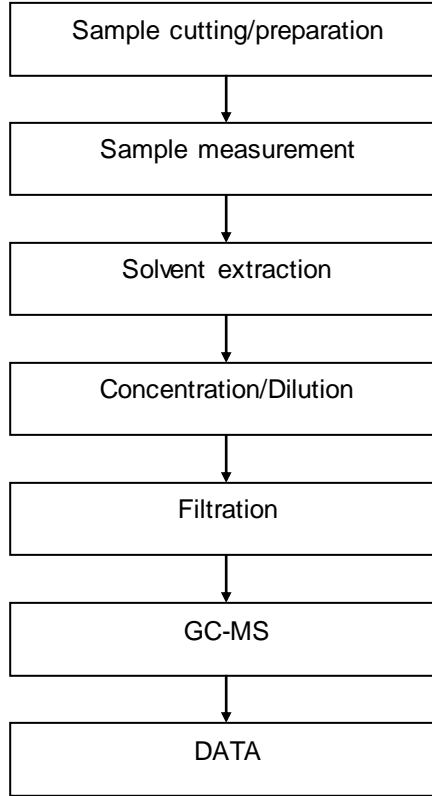

SGS CSTC (Shanghai) Inspection & Testing Services Co., Ltd.  
Testing Center-Chemical Laboratory

Unless otherwise agreed in writing, this document is issued by the Company subject to its General Conditions of Service printed overleaf, available on request or accessible at <http://www.sgs.com/en/Terms-and-Conditions.aspx> and, for electronic format documents, subject to Terms and Conditions for Electronic Documents at <http://www.sgs.com/en/Terms-and-Conditions/Terms-e-Documents.aspx>. Attention is drawn to the limitation of liability, indemnification and jurisdiction issues defined therein. Any holder of this document is advised that information contained hereon reflects the Company's findings at the time of its intervention only and within the limits of Client's instructions, if any. The Company's sole responsibility is to its Client and this document does not exonerate parties to a transaction from exercising all their rights and obligations under the transaction documents. This document cannot be reproduced except in full, without prior written approval of the Company. Any unauthorized alteration, forgery or falsification of the content or appearance of this document is unlawful and offenders may be prosecuted to the fullest extent of the law. Unless otherwise stated the results shown in this test report refer only to the sample(s) tested.

Attention: To check the authenticity of testing /inspection report & certificate, please contact us at telephone: (86-755) 8307 1443, or email: [CN.Doccheck@sgs.com](mailto:CN.Doccheck@sgs.com)

3<sup>rd</sup> Building, No.889 Yishan Road Xuhui District, Shanghai China 200233 t E&E (86-21) 61402553 f E&E (86-21) 64953679 www.sgsgroup.com.cn  
中国·上海·徐汇区宜山路889号3号楼 邮编: 200233 t HL (86-21) 61402594 f HL (86-21) 61156899 e [sgs.china@sgs.com](mailto:sgs.china@sgs.com)



### PVC Testing Flow Chart

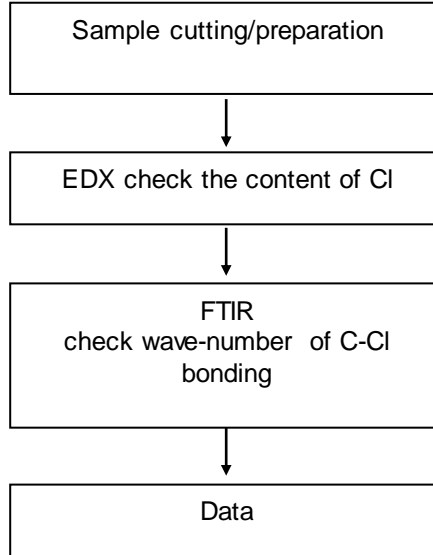

SGS CSTC (Shanghai) Technical Services Co., Ltd.  
Testing Center-Chemical Laboratory

Unless otherwise agreed in writing, this document is issued by the Company subject to its General Conditions of Service printed overleaf, available on request or accessible at <http://www.sgs.com/en/Terms-and-Conditions.aspx> and, for electronic format documents, subject to Terms and Conditions for Electronic Documents at <http://www.sgs.com/en/Terms-and-Conditions/Terms-e-Documents.aspx>. Attention is drawn to the limitation of liability, indemnification and jurisdiction issues defined therein. Any holder of this document is advised that information contained hereon reflects the Company's findings at the time of its intervention only and within the limits of Client's instructions, if any. The Company's sole responsibility is to its Client and this document does not exonerate parties to a transaction from exercising all their rights and obligations under the transaction documents. This document cannot be reproduced except in full, without prior written approval of the Company. Any unauthorized alteration, forgery or falsification of the content or appearance of this document is unlawful and offenders may be prosecuted to the fullest extent of the law. Unless otherwise stated the results shown in this test report refer only to the sample(s) tested.

Attention: To check the authenticity of testing / inspection report & certificate, please contact us at telephone: (86-755) 8307 1443, or email: [CN.Doccheck@sgs.com](mailto:CN.Doccheck@sgs.com)

3<sup>rd</sup> Building, No.889 Yishan Road Xuhui District, Shanghai China 200233 t E&E (86-21) 61402553 f E&E (86-21) 64953679 www.sgsgroup.com.cn  
中国·上海·徐汇区宜山路889号3号楼 邮编: 200233 t HL (86-21) 61402594 f HL (86-21) 61156899 e sgs.china@sgs.com

## Red Phosphorus Testing Flow Chart

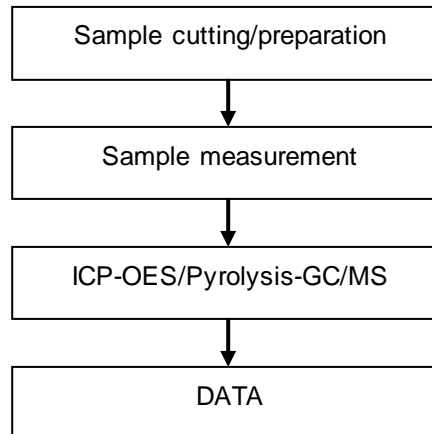

Unless otherwise agreed in writing, this document is issued by the Company subject to its General Conditions of Service printed overleaf, available on request or accessible at <http://www.sgs.com/en/Terms-and-Conditions.aspx> and, for electronic format documents, subject to Terms and Conditions for Electronic Documents at <http://www.sgs.com/en/Terms-and-Conditions/Terms-e-Documents.aspx>. Attention is drawn to the limitation of liability, indemnification and jurisdiction issues defined therein. Any holder of this document is advised that information contained hereon reflects the Company's findings at the time of its intervention only and within the limits of Client's instructions, if any. The Company's sole responsibility is to its Client and this document does not exonerate parties to a transaction from exercising all their rights and obligations under the transaction documents. This document cannot be reproduced except in full, without prior written approval of the Company. Any unauthorized alteration, forgery or falsification of the content or appearance of this document is unlawful and offenders may be prosecuted to the fullest extent of the law. Unless otherwise stated the results shown in this test report refer only to the sample(s) tested.

Attention: To check the authenticity of testing / inspection report & certificate, please contact us at telephone: (86-755) 8307 1443, or email: [CN.Doccheck@sgs.com](mailto:CN.Doccheck@sgs.com)

SGS-TESTING  
SGS-TESTING  
Testing Center-Chemical Laboratory

3<sup>rd</sup> Building, No.889 Yishan Road Xuhui District, Shanghai China 200233 t E&E (86-21) 61402553 f E&E (86-21) 64953679 www.sgsgroup.com.cn  
中国·上海·徐汇区宜山路889号3号楼 邮编: 200233 t HL (86-21) 61402594 f HL (86-21) 61156899 e sgs.china@sgs.com

### PFASs/ PFOS/PFOA Testing Flow Chart

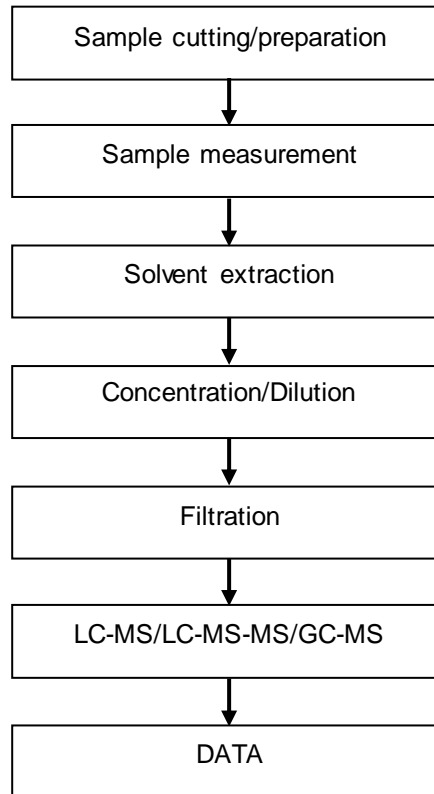

SGS-CSTC Standards Technical Services (Shanghai) Co., Ltd.  
Testing Center-Chemical Laboratory

Unless otherwise agreed in writing, this document is issued by the Company subject to its General Conditions of Service printed overleaf, available on request or accessible at <http://www.sgs.com/en/Terms-and-Conditions.aspx> and, for electronic format documents, subject to Terms and Conditions for Electronic Documents at <http://www.sgs.com/en/Terms-and-Conditions/Terms-e-Documents.aspx>. Attention is drawn to the limitation of liability, indemnification and jurisdiction issues defined therein. Any holder of this document is advised that information contained hereon reflects the Company's findings at the time of its intervention only and within the limits of Client's instructions, if any. The Company's sole responsibility is to its Client and this document does not exonerate parties to a transaction from exercising all their rights and obligations under the transaction documents. This document cannot be reproduced except in full, without prior written approval of the Company. Any unauthorized alteration, forgery or falsification of the content or appearance of this document is unlawful and offenders may be prosecuted to the fullest extent of the law. Unless otherwise stated the results shown in this test report refer only to the sample(s) tested.

Attention: To check the authenticity of testing /inspection report & certificate, please contact us at telephone: (86-755) 8307 1443, or email: [CN.Doccheck@sgs.com](mailto:CN.Doccheck@sgs.com)

3<sup>rd</sup> Building, No.889 Yishan Road Xuhui District, Shanghai China 200233 t E&E (86-21) 61402553 f E&E (86-21) 64953679 www.sgsgroup.com.cn  
中国·上海·徐汇区宜山路889号3号楼 邮编: 200233 t HL (86-21) 61402594 f HL (86-21) 61156899 e [sgs.china@sgs.com](mailto:sgs.china@sgs.com)

### PAHs Testing Flow Chart

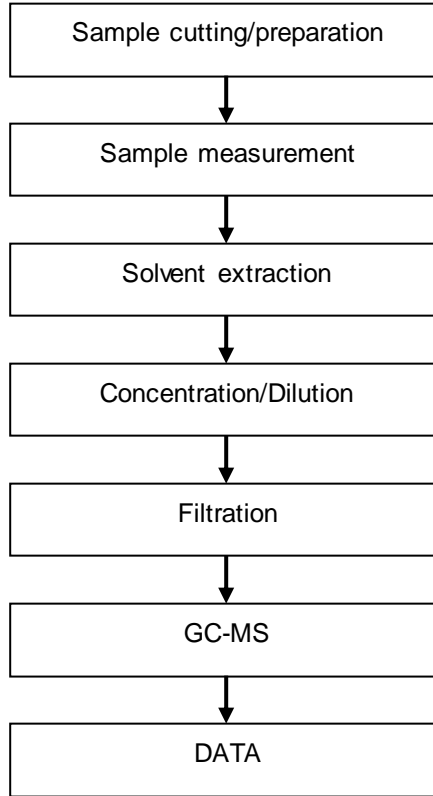

SGS-CSST (Shanghai) Co., Ltd.  
Testing Center-Chemical Laboratory

Unless otherwise agreed in writing, this document is issued by the Company subject to its General Conditions of Service printed overleaf, available on request or accessible at <http://www.sgs.com/en/Terms-and-Conditions.aspx> and, for electronic format documents, subject to Terms and Conditions for Electronic Documents at <http://www.sgs.com/en/Terms-and-Conditions/Terms-e-Documents.aspx>. Attention is drawn to the limitation of liability, indemnification and jurisdiction issues defined therein. Any holder of this document is advised that information contained hereon reflects the Company's findings at the time of its intervention only and within the limits of Client's instructions, if any. The Company's sole responsibility is to its Client and this document does not exonerate parties to a transaction from exercising all their rights and obligations under the transaction documents. This document cannot be reproduced except in full, without prior written approval of the Company. Any unauthorized alteration, forgery or falsification of the content or appearance of this document is unlawful and offenders may be prosecuted to the fullest extent of the law. Unless otherwise stated the results shown in this test report refer only to the sample(s) tested.

Attention: To check the authenticity of testing / inspection report & certificate, please contact us at telephone: (86-755) 8307 1443, or email: [CN.Doccheck@sgs.com](mailto:CN.Doccheck@sgs.com)

3<sup>rd</sup> Building, No. 889 Yishan Road Xuhui District, Shanghai China 200233 t E&E (86-21) 61402553 f E&E (86-21) 64953679 www.sgsgroup.com.cn  
中国·上海·徐汇区宜山路889号3号楼 邮编: 200233 t HL (86-21) 61402594 f HL (86-21) 61156899 e [sgs.china@sgs.com](mailto:sgs.china@sgs.com)

## Test Report

No.: SHAEC23000646729\_1

Date: May 06, 2023

Page 25 of 25

Sample Photo:



SGS authenticate the photo on original report only  
 \*\*\* End of Report \*\*\*



SGS-CSTC Standards Technical Services (Shanghai) Co., Ltd.  
 Testing Center-Chemical Laboratory

Unless otherwise agreed in writing, this document is issued by the Company subject to its General Conditions of Service printed overleaf, available on request or accessible at <http://www.sgs.com/en/Terms-and-Conditions.aspx> and, for electronic format documents, subject to Terms and Conditions for Electronic Documents at <http://www.sgs.com/en/Terms-and-Conditions/Terms-e-Documents.aspx>. Attention is drawn to the limitation of liability, indemnification and jurisdiction issues defined therein. Any holder of this document is advised that information contained hereon reflects the Company's findings at the time of its intervention only and within the limits of Client's instructions, if any. The Company's sole responsibility is to its Client and this document does not exonerate parties to a transaction from exercising all their rights and obligations under the transaction documents. This document cannot be reproduced except in full, without prior written approval of the Company. Any unauthorized alteration, forgery or falsification of the content or appearance of this document is unlawful and offenders may be prosecuted to the fullest extent of the law. Unless otherwise stated the results shown in this test report refer only to the sample(s) tested.

Attention: To check the authenticity of testing / inspection report & certificate, please contact us at telephone: (86-755) 8307 1443, or email: [CN.Doccheck@sgs.com](mailto:CN.Doccheck@sgs.com)

3<sup>rd</sup> Building, No. 889 Yishan Road Xuhui District, Shanghai China 200233 t E&E (86-21) 61402553 f E&E (86-21) 64953679 www.sgs.com.cn  
 中国·上海·徐汇区宜山路889号3号楼 邮编: 200233 t HL (86-21) 61402594 f HL (86-21) 61156899 e sgs.china@sgs.com