

Electronic Energy Meter (Smart Meter)



The global demand for energy is insatiable. As energy demands increase, it is ever more important that consumption is monitored and regulated on a real-time basis. Smart metering makes possible the coordination of energy production and demand, the immediate reporting of disruptions, and provides the consumer a tool to manage individual consumption. Central Semiconductor manufactures discrete devices critical to the efficient and reliable operation of smart meters. Central's discrete semiconductors are used in all functions of smart meter topologies.

For more information visit: www.centrasemi.com/applications

Electronic Energy Meter (Smart Meter) Topology

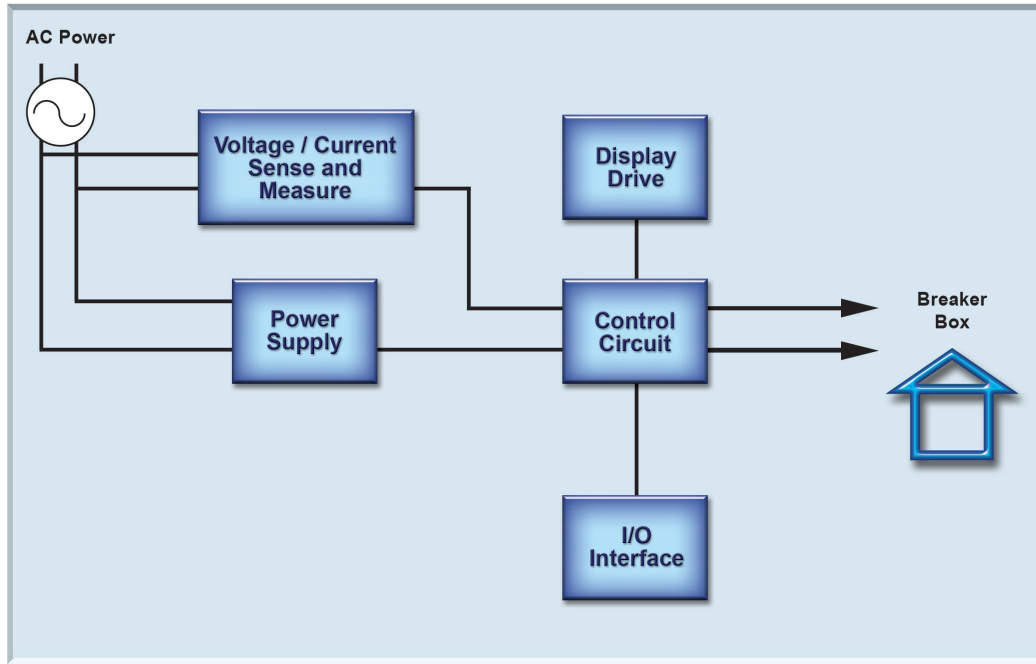

Voltage/Current Sense and Measure

• Bridge Rectifiers (Full Wave)

- CBR1-D040S: 400V, 1.0A (SMDIP)
- CBR1-D060S: 600V, 1.0A (SMDIP)
- CBR2-D040S: 400V, 2.0A (SMDIP)
- CBR2-D060S: 600V, 2.0A (SMDIP)

• Bi-Directional Transient Voltage Suppressors (Specified by Stand-Off Voltage)

- 1SMB170CA: 600W, 170V (SMB)
- P6SMB200CA: 600W, 171V (SMB)
- 1SMC170CA: 1.5kW, 170V (SMC)
- 1.5SMC200CA: 1.5kW, 171V (SMC)
- 3SMC170CA: 3.0kW, 170V (SMC)

• Schottky Diodes

- CMLSH05-4: 40V, 500mA (SOT-563)
- CMKSH-3T: 30V, 100mA, Triple Isolated (SOT-363)

• Zener Diodes

- CMOZ3V3 thru CMOZ15V: 350mW, 3.3V -15V (SOD-523)
- CMHZ5226B thru CMHZ5245B: 500mW, 3.3V to 15V (SOD-123)

• Small Signal Diodes

- CMOD2005: 350V, 250mA (SOD-523)
- CMXD2004: 300V, 225mA Triple Isolated (SOT-26)

• Current Limiting Diodes

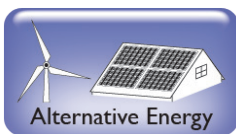

- CMJH100: 10mA, 3.5V (SOD-123FL)
- CMJH150: 15mA, 4.3V (SOD-123FL)



Electronic Energy Meter (Smart Meter)

Display Drive

• MOSFETs

- 
 - CMPDM203NH: 20V, 3.2A N-Channel (SOT-23F)
 - CMPDM302PH: 30V, 2.4A P-Channel (SOT-23F)
- 
 - CMLDM7005: 20V, 650mA Dual, N-Channel (SOT-563)

• Small Signal Transistors



- 
 - CMUT3904: 0.2A, 40V NPN (SOT-523)
 - CMUT3906: 0.2A, 40V PNP (SOT-523)

• Schottky Diodes

- 
 - CMKSH-3T: 30V, 100mA Triple, Isolated (SOT-363)

Power Supply



• Bridge Rectifiers (Full Wave)

- 
 - CBR1-D060S: 600V, 1.0A (SMDIP)
 - CBR2-D060S: 600V, 2.0A (SMDIP)
- 
 - CBR4M-L040: 400V, 4.0A (Case DM)

• Bi-Directional Transient Voltage Suppressors (Specified by Stand-Off Voltage)

- 
 - 1SMC170CA: 1.5kW, 170V (SMC)
 - 3SMC170CA: 3.0kW, 170V (SMC)

• Schottky Rectifiers

- 
 - CMSH3-60M: 60V, 3.0A (SMB)
- 
 - CMSH5-60: 60V, 5.0A (SMC)
- 
 - CMDFSHC3-100: 100V, 3.0A (SMC DFN)
 - CMDFSHC5-100: 100V, 5.0A (SMC DFN)

• Ultrafast Rectifiers

- 
 - CMR2U-06: 600V, 2.0A, 100ns (SMB)
 - CMR3U-06M: 600V, 3.0A, 100ns (SMB)

• MOSFETs

- 
 - CMPDM203NH: 20V, 3.2A N-Channel (SOT-23F)
 - CMPDM302PH: 30V, 2.4A P-Channel (SOT-23F)

Control Circuit

• Current Limiting Diodes

- 
 - CMJH100: 10mA, 3.5V (SOD-123FL)
 - CMJH150: 15mA, 4.3V (SOD-123FL)



• Zener Diodes

- 
 - CMHZ5226B thru CMHZ5245B: 500mW, 3.3V to 15V (SOD-123)

• MOSFETs



- 
 - CMUDM7005: 20V, 0.65A N-Channel (SOT-523)
 - CMUDM8005: 20V, 0.65A P-Channel (SOT-523)

• Small Signal Transistors



- 
 - CZT2222A: 0.6A, 40V NPN (SOT-223)
- 
 - CMUT3904: 0.2A, 40V NPN (SOT-523)
 - CMUT3906: 0.2A, 40V PNP (SOT-523)

I/O Interface

• ESD Transient Voltage Suppressors

- 
 - CSL05: 400W, 5.0V, Ultra Low Capacitance (SOT-23)
 - CSL05D: 400W, 5.0V, Dual, Ultra Low Capacitance (SOT-23)
 - CMPLC1V5D: 50W, 1.5V, Dual Ultra Low Capacitance (SOT-23)
- 
 - CMNTVS12V: 18W, 12V Quad, Low Capacitance (SOT-953)
- 
 - CTLTVS12: 35W, 12V Low Capacitance (TLM2D3D6)

• Schottky Diodes

- 
 - CMASH-4: 200mA, 40V (SOD-923)
- 
 - CMRSH-4DO: 200mA, 40V Dual, Opposing (SOT-963)

• Small Signal Diodes

- 
 - CMXD2004: 300V, 225mA Triple Isolated (SOT-26)