



Hearing Aid



Impaired hearing is a growing global concern. Current trends in hearing assistance devices demand smaller, higher performing designs with extended battery life. Central manufactures a host of products that assist designers in achieving these objectives.

For more information visit: www.centrasemi.com/product/hearing

Basic Hearing Aid Topology

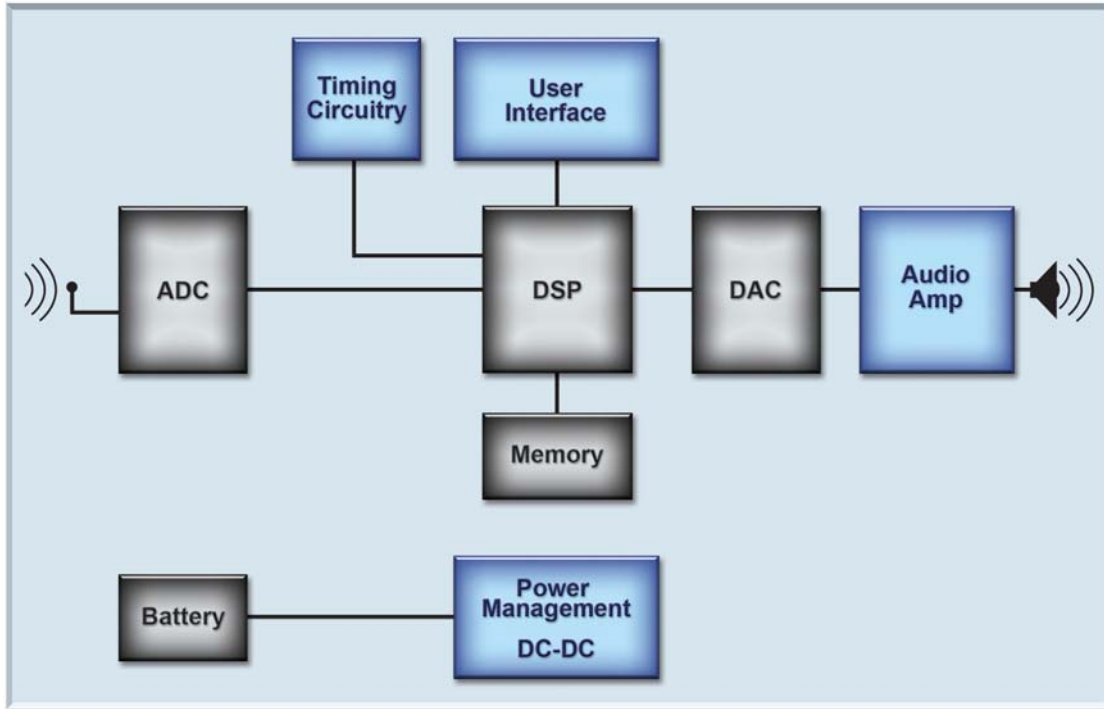

Timing Circuitry

- High Speed Switching Diode

-CMAD4448: 250mA, 120V (SOD-923)

- Schottky Diodes

-CMRD6263DO: 15mA, 70V Dual, Opposing (SOT-963)

-CMRSH-4DO: 200mA, 40V Dual, Opposing (SOT-963)

-CMASH-4: 200mA, 40V (SOD-923)

- MOSFETs

-CMNDM7001: 100mA, 20V N-Channel (SOT-953)

-CMNDM8001: 100mA, 20V P-Channel (SOT-953)

For more information visit: www.centrasemi.com/apps/tc3

User Interface

- ESD Transient Voltage Suppressors

-CMNTVS12V: 18W, 12V TVS Array (SOT-953)

-CSL05: 400W, 5.0V Low Capacitance (SOT-23)

-CSL05D: 400W, 5.0V Low Capacitance Dual (SOT-23)

- Schottky Diodes

-CMRD6263DO: 15mA, 70V Dual, Opposing (SOT-963)

-CMASH-4: 200mA, 40V (SOD-923)

For more information visit: www.centrasemi.com/apps/ui3







Audio Amp and Power Management DC-DC continued on reverse side →





Medical

Audio Amp

• Small Signal Transistors

-  CMUT3904: 200mA, 40V NPN (SOT-523)
-  CMUT3906: 200mA, 40V PNP (SOT-523)
-  CMBT3904E: 200mA, 40V NPN (SOT-923)
-  CMBT3906E: 200mA, 40V PNP (SOT-923)
-  CMNT3904E: 200mA, 40V NPN (SOT-953)
-  CMNT3906E: 200mA, 40V PNP (SOT-953)

• Schottky Diodes

-  -CMASH-4: 200mA, 40V (SOD-923)
-  -CMRSH-4DO: 200mA, 40V Dual, Opposing (SOT-963)



• High Speed Switching Diode

-  -CMLD4448: 250mA, 120V Dual, Isolated (SOT-563)



For more information visit: www.centrasemi.com/apps/aa3

Power Management DC-DC





• Small Signal Transistors

-  CMLT3904E: 200mA, 40V NPN (SOT-563)
-  CMLT3906E: 200mA, 40V PNP (SOT-563)



• Schottky Diodes

-  -CMASH-4: 200mA, 40V (SOD-923)
-  -CMRSH-4DO: 200mA, 40V Dual, Opposing (SOT-963)
-  -CMLSH05-4: 0.5A, 40V (SOT-563)

• MOSFETs

-  CMUDM7001: 100mA, 20V N-Channel (SOT-523)
-  CMUDM8001: 100mA, 20V P-Channel (SOT-523)
-  CMLDM7002A: 280mA, 60V Dual, N-Channel (SOT-563)
-  CMLDM8002A: 280mA, 50V Dual, P-Channel (SOT-563)

• Multi Discrete Modules (MDMs)

-  CMLM0574: **Combination:** 450mA, 30V N-Channel MOSFET and 0.5A, 40V Schottky Diode (SOT-563)
-  CMLM0584: **Combination:** 450mA, 30V P-Channel MOSFET and 0.5A, 40V Schottky Diode (SOT-563)

• Zener Diodes

-  -CMOZ3V3 thru CMOZ12V: 250mW, 3.3V thru 12V (SOD-523)

For more information visit: www.centrasemi.com/apps/pmdd3

Samples



To order samples of these devices visit:
<http://web.centrasemi.com/search/sample.php>

Literature



New
SMD
SELECTION
GUIDE

Order your selection guide today.
Visit: web.centrasemi.com/search/sample.php



Innovative Discrete Semiconductors

For further information contact:
Sales at Central Semiconductor Corp.
(631) 435-1110 or visit:
www.centrasemi.com